

KOHLER[®] SNOW PRO
HORIZONTAL CRANKSHAFT

WH208

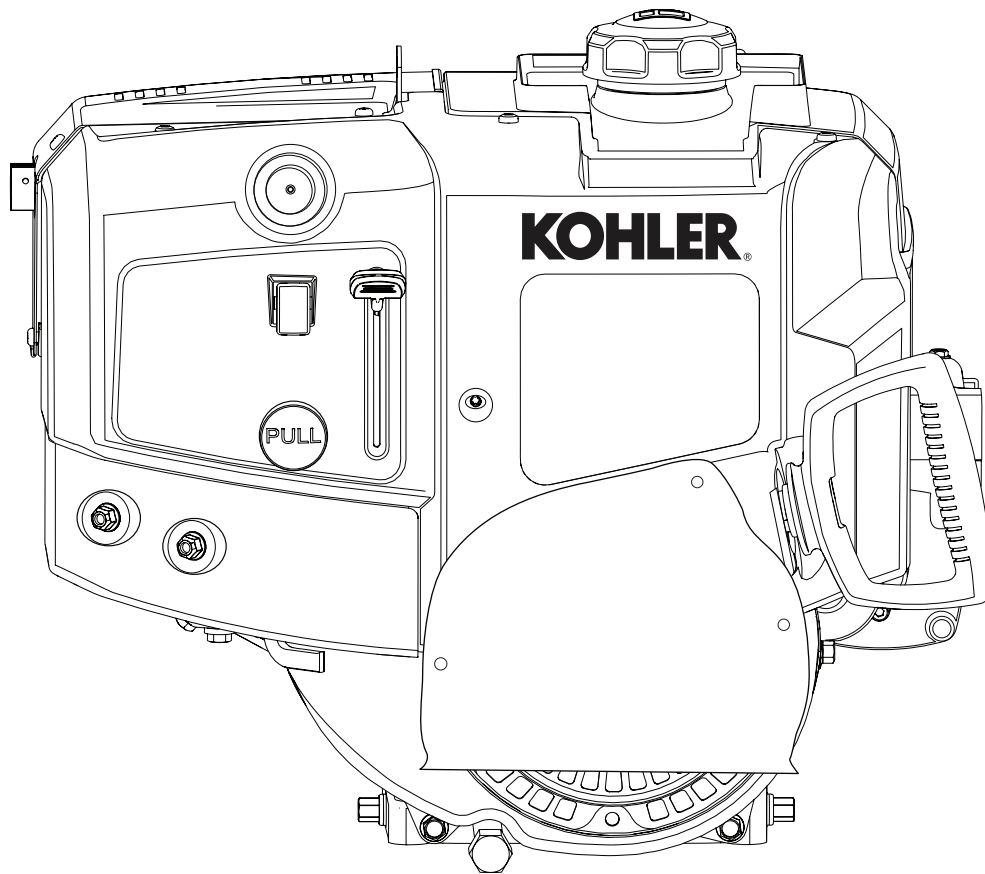

This Manual Provides the Needed Information to Service the WH208 Engine. Please See the CH270 Service Manual For Information Not Covered Here.

NOTE: This engine is intended for winter use.

⚠ WARNING



Electrical Shock can cause severe injury or death.

Use only a 3 wire extension cord with a Ground Fault Circuit Interrupter (GFCI) outlet.

Electrical Shock!
Use only a 3-wire extension cord and Ground Fault Circuit Interrupter (GFCI) outlet. Plug into the engine first then the wall outlet. After starting, remove cord from wall outlet first, then remove from the electric starter.

Engine Identification Numbers

When ordering parts, or in any communication involving an engine, always give the Model, Specification, and Serial Numbers, including letter suffixes if there are any.

The engine identification numbers appear on a decal, or decals, affixed to the engine shrouding. An explanation of these numbers is shown in Figure 1.

A. Model No. **WH208**
 Winter Engine _____
 Horizontal Crankshaft _____
 Numerical Designation _____

B. Spec. No. **WH208-0001**
 Model No. _____
 Variation No. of _____
 Basic Spec. _____

C. Serial No. **39,24895008**
 Year Manufactured Code _____

<u>Code</u>	<u>Year</u>	
39	2009	Factory Code
40	2010	

Figure 1. Explanation of Engine Identification Numbers.

Oil Recommendations

Using the proper type and weight of oil in the crankcase is extremely important. So is checking oil daily and changing oil regularly. Failure to use the correct oil, or using dirty oil, causes premature engine wear and failure.

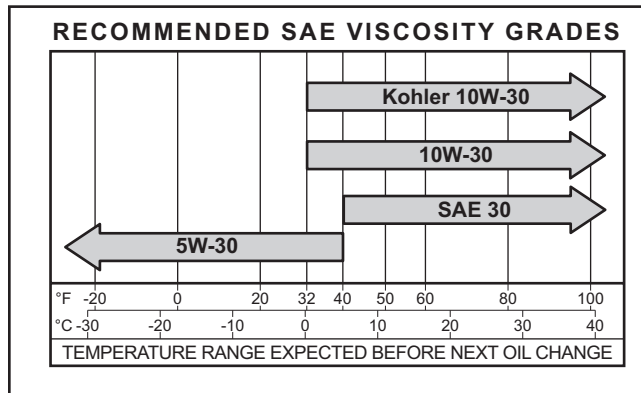

Figure 2. Oil Viscosity Grades Table.

Maintenance Schedule

These required maintenance procedures should be performed at the frequency stated in the table below. They should also be included as part of any seasonal tune-up.

Frequency	Maintenance Required
Daily or Before Starting Engine	Check oil level.
	Fill fuel tank.
	Check air intake and cooling areas; clean as necessary.
Yearly	Change oil.
Every 100 Hours	Clean cooling areas.
	Replace spark plug, and set gap.
	Replace fuel filter (if equipped).

Perform the following steps to remove the engine cover, electric starter, fuel tank, and the engine control assembly.

Remove Control Knobs

Choke

1. Pull the choke control knob out. Pry the linkage out from underneath the knob and lift the knob off the linkage and remove from the engine cover. See Figure 4.

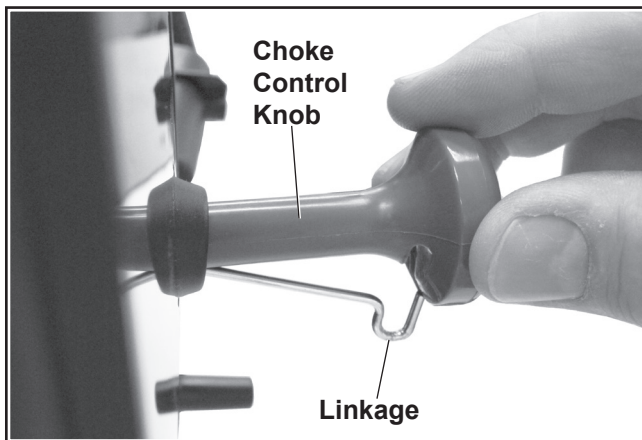

Figure 4. Remove Choke Knob.

Throttle

1. Pull the control lever knob off the control lever. See Figure 5.



Figure 5. Remove Key and Control Lever Knob.

Stop/Run Key

1. Pull out the stop/run key. See Figure 5.

Remove Retractable Starter Cover

1. Remove the Torx screws securing the retractable starter cover, and remove the cover. See Figure 6.

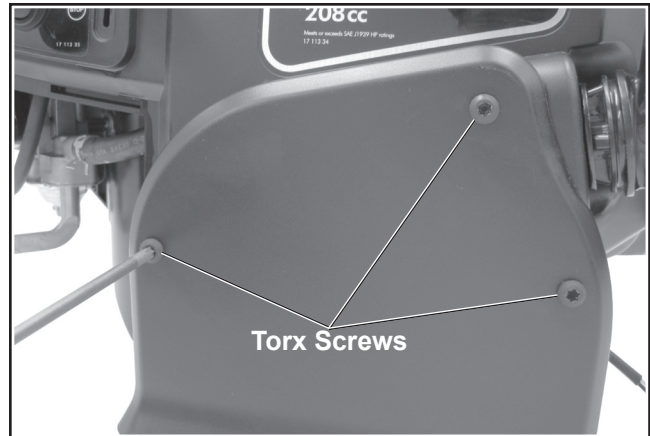

Figure 6. Remove Cover Torx Screws.

Remove Air Box Cover

1. Remove the hex flange nuts from the air box cover and remove the cover. See Figure 7.

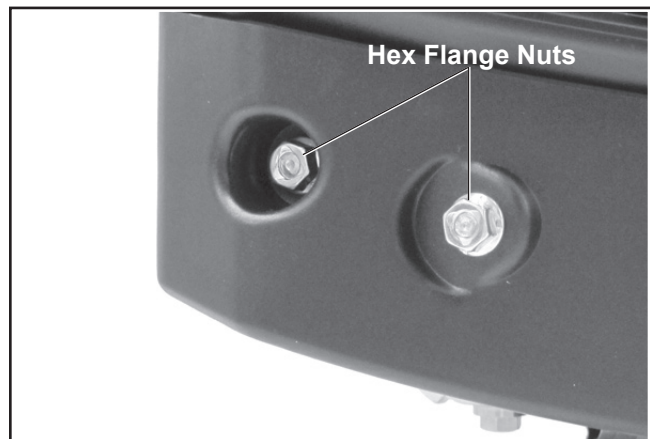

Figure 7. Remove Cover.

Remove Engine Cover

1. Remove the hex flange shoulder screws retaining the engine cover to the blower housing. See Figure 8.

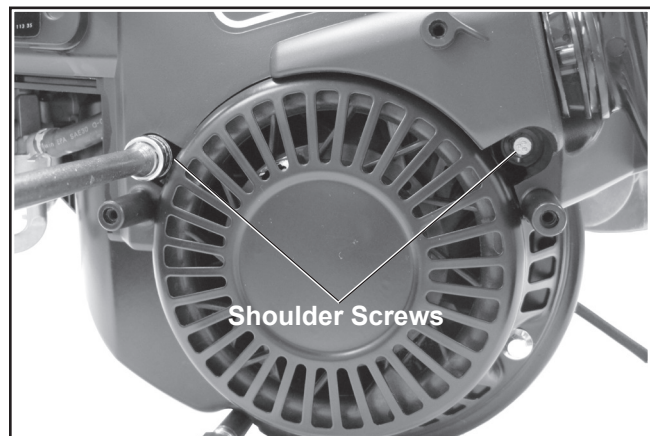

Figure 8. Remove Shoulder Screws.

- Remove the Torx screws securing the engine cover. See Figure 9.



Figure 9. Remove Torx Screws.

- Do not fully remove the cover from the engine. The primer hose and the key switch wires are still attached at this time.

Disconnect Primer Assembly Hose

- Pull the hose off the back of the primer assembly. See Figure 10.

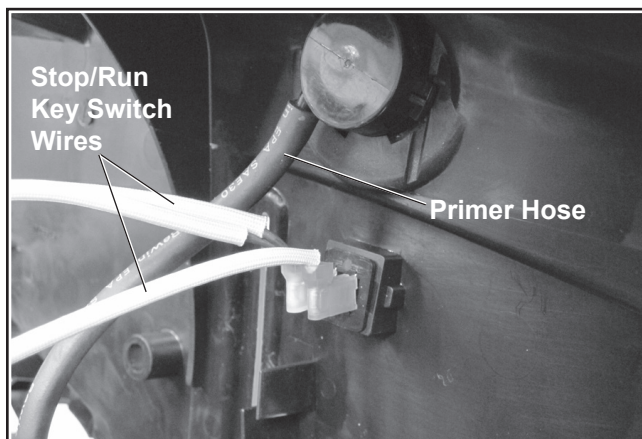

Figure 10. Remove Hose and Wires.

Disconnect Key Switch Wires

- Remove the stop/run key switch wires from the back of the engine cover. See Figure 10.
- The engine cover can now be set aside.

Remove Air Box

- Remove one hex flange screw and two hex nuts securing the air box to the carburetor, and remove the air box from the studs. See Figures 11 and 12.

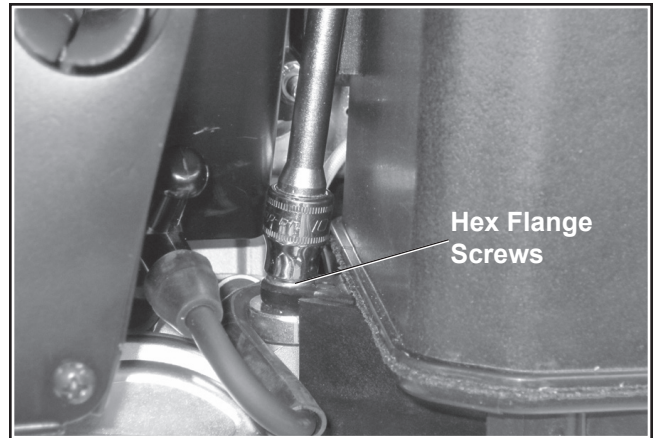

Figure 11. Remove Air Box Screw.

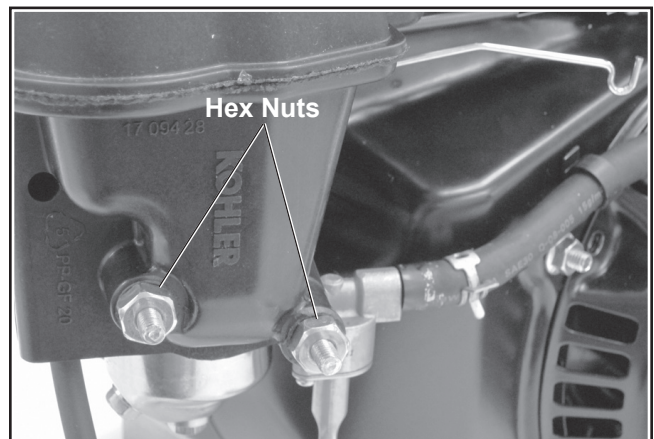

Figure 12. Remove Air Box Hex Nuts.

Remove Electric Starter (If Equipped)

- Remove the hex flange screws securing the electric starter to the crankcase, and remove the electric starter. See Figure 13.

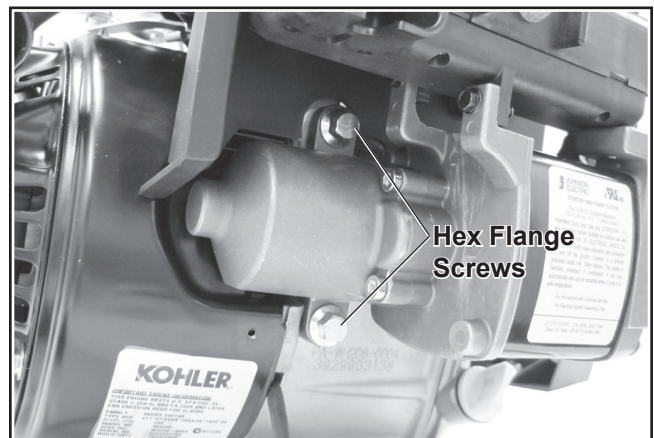

Figure 13. Remove Electric Starter.

Remove Fuel Tank

1. Remove the hex flange screws securing the engine extension cover, and remove the engine extension cover. See Figure 14.

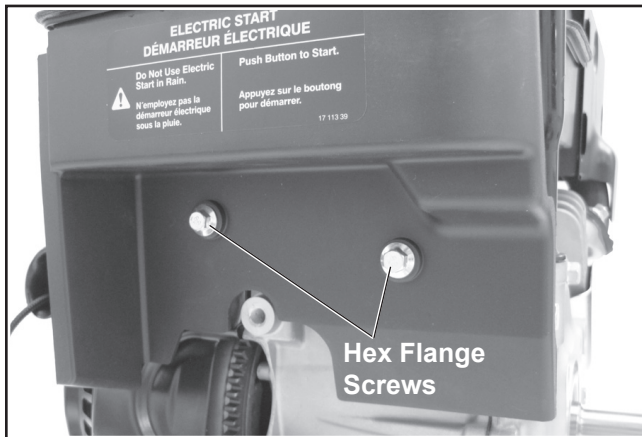

Figure 14. Remove Cover Hex Flange Screws.

2. Remove the hex flange screw securing the dipstick tube. Remove the tube. See Figure 15.

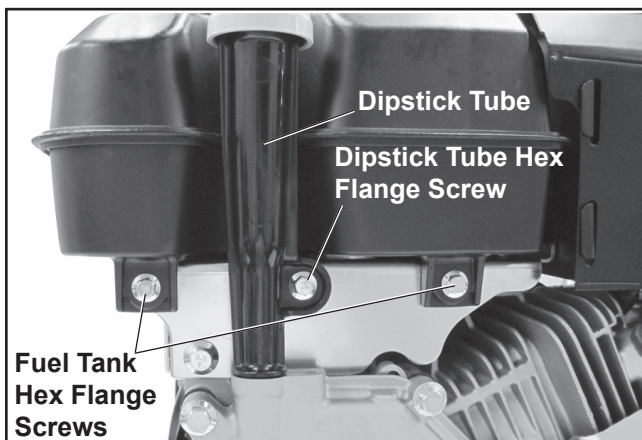

Figure 15. Remove Dipstick Tube.

3. Remove the hex flange screws securing the fuel tank to the control assembly. See Figures 15 and 16.

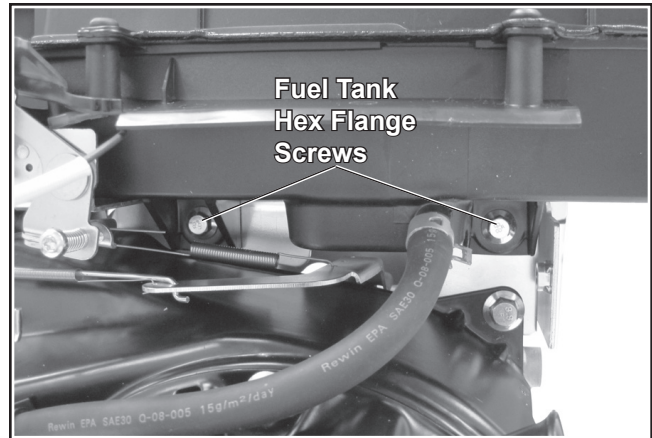

Figure 16. Remove Fuel Tank Hex Flange Screws.

4. Remove the fuel line from carburetor, and remove the tank from the bracket. See Figure 17.

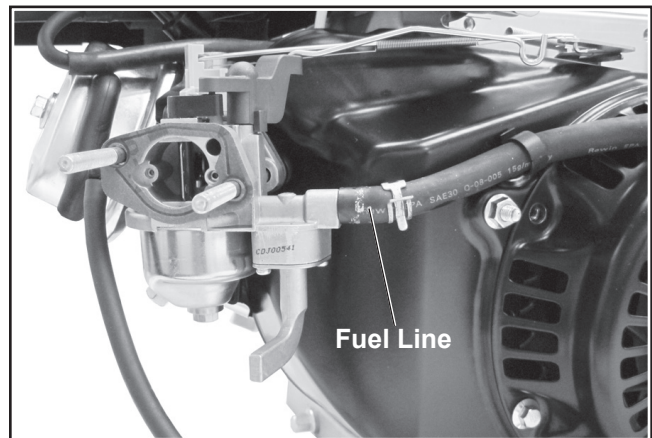

Figure 17. Remove Fuel Line from Carburetor.

Remove Muffler

1. Remove the hex flange screws securing the muffler to the head. See Figure 18.

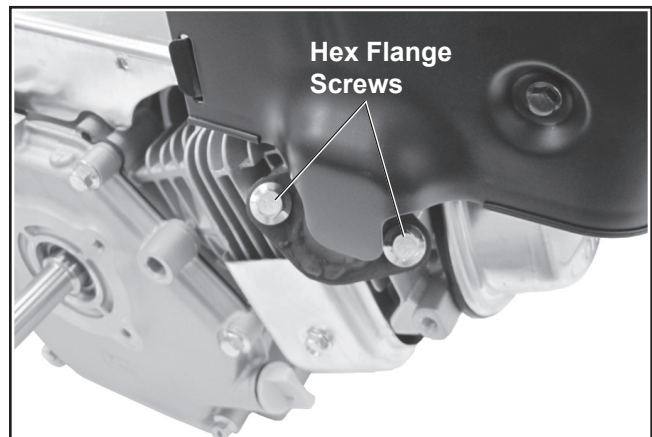

Figure 18. Remove Hex Flange Screws.

- Remove the hex nut, and remove the muffler. See Figure 19.

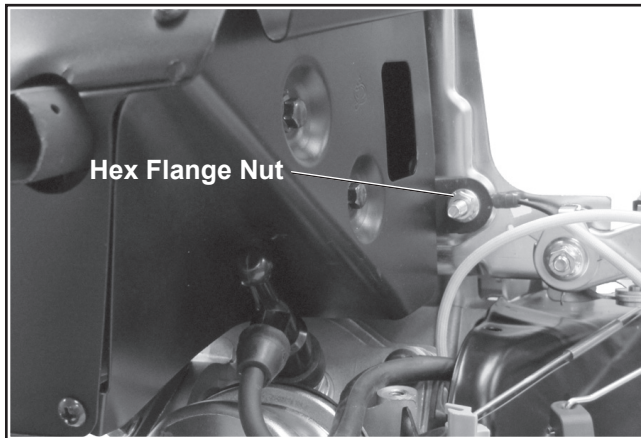

Figure 19. Remove Hex Flange Nut.

- Remove the exhaust gasket from the outlet.

Remove Engine Control Assembly

- Disconnect the governor spring from the control lever spring arm. See Figure 20.

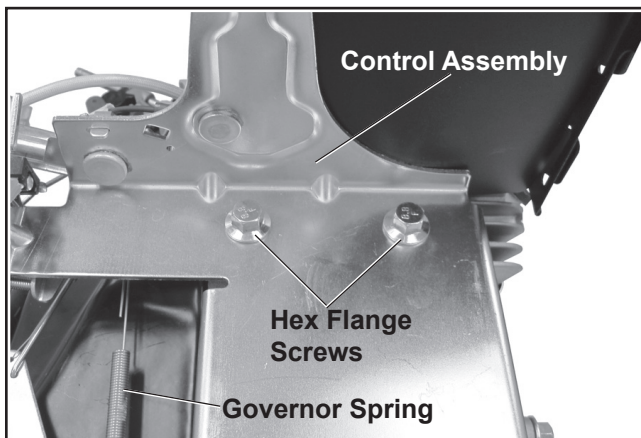

Figure 20. Remove Hex Flange Screws.

- Remove the hex flange screws, and remove the control assembly. See Figures 20 and 21.

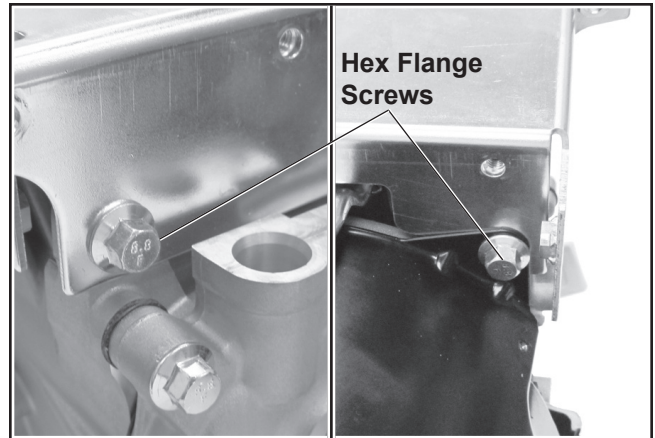

Figure 21. Remove Hex Flange Screws.

NOTE: Reverse the previous steps to reassemble the engine, referring to the torque specifications on Page 11.

NOTE: If further disassembly of the engine is needed, reference the CH270 service manual for more information.

Engine Control Lever Assembly

- Assemble the control lever assembly as follows: flat washer, nylon washer, control lever, spring washer, control lever washer, with the locking hex flange nut torqued such that it requires $6 \pm 1 \text{ lb. (2.72} \pm 0.45 \text{ kg)}$ to move the control lever at location A. See Figure 22.

NOTE: The spring washer shape should cup towards the control lever washer.

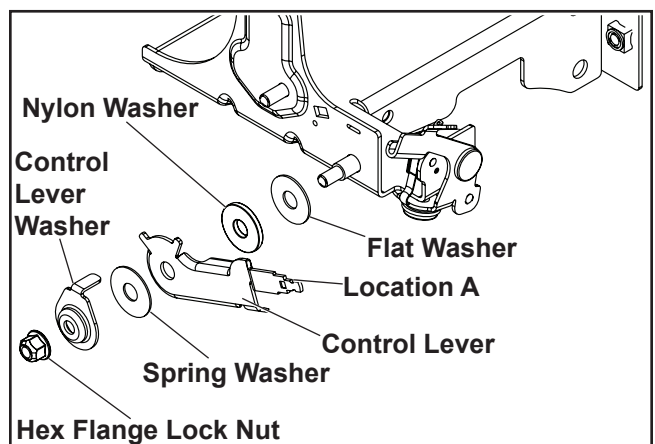

Figure 22. Engine Control Lever.

NOTE: A spring scale or hanging weight are the preferred method to apply the required load force. If these are not available, adjust the nut so it has adequate resistance to keep the lever in place.

2. With the applied load force at location **A**, begin to slowly loosen the lock nut until the lever can barely rotate to the full downward (stop) position.

Adjusting Governor Lever

To adjust the governor lever, the air box has to be installed and tightened on the carburetor studs to hold the carburetor in its normal position.

1. Loosen the governor lever hex flange nut. Push and hold the governor lever in the direction indicated in Figure 23. Continue holding in this direction throughout this procedure. Turn the governor shaft clockwise until it stops. Tighten the hex flange nut on the governor lever clamp bolt to lock the lever on the shaft. Torque the nut to 10 N·m (89 in. lb.).

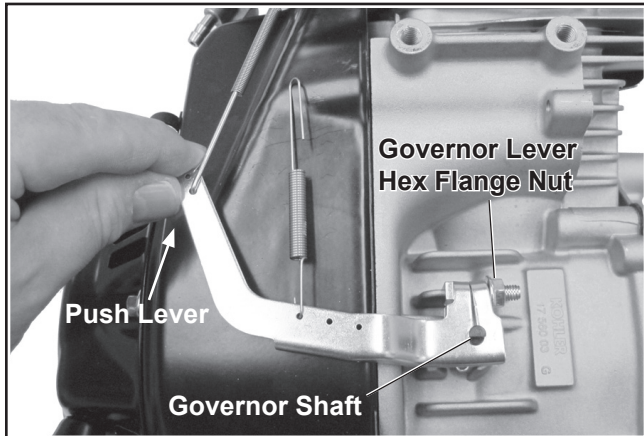

Figure 23. Governor Lever Adjustment.

Fuel Filter

Replace the in-nipple fuel filter every 100 hours of operation, with a genuine Kohler filter. Remove the air box cover, retractable starter cover, and engine cover to access the fuel line. See Figure 24.

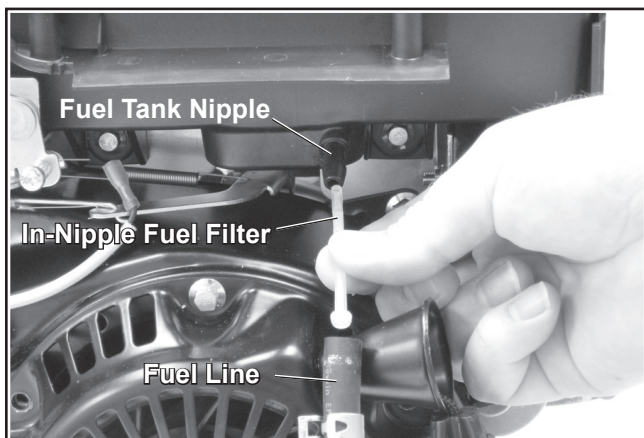

Figure 24. In-Nipple Fuel Filter.

1. Remove the fuel line to access the fuel filter. The fuel filter may remain in the fuel line when the fuel line is removed. Pull the fuel filter out of the fuel tank nipple or the fuel line and discard.
2. Insert a new fuel filter into the fuel tank nipple and push the fuel line onto the fuel tank nipple.

Check Spark Plug

Every 100 hours of operation, remove the spark plug, check condition, and reset the gap or replace with a new plug as necessary. The original spark plug is a Champion® XC12YC. Equivalent alternate brand plugs can also be used. Refer to the CH270 service manual for instructions to service the spark plug.

Electronic Ignition System and Stator

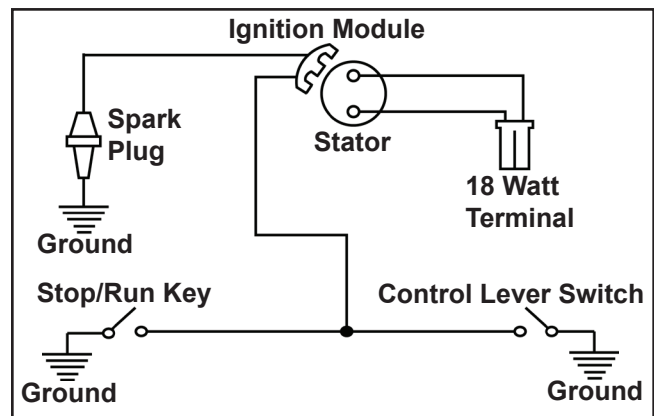

Figure 25. Wiring Diagram.

Check Oil Level

The importance of checking and maintaining the proper oil level in the crankcase cannot be overemphasized. Check oil **BEFORE EACH USE** as follows:

1. Make sure the engine is stopped, level, and is cool so the oil has had time to drain into the sump.
2. Clean the area around and beneath the dipstick before removing it. This will help keep snow, ice, and other foreign matter out of the engine. See Figure 26.

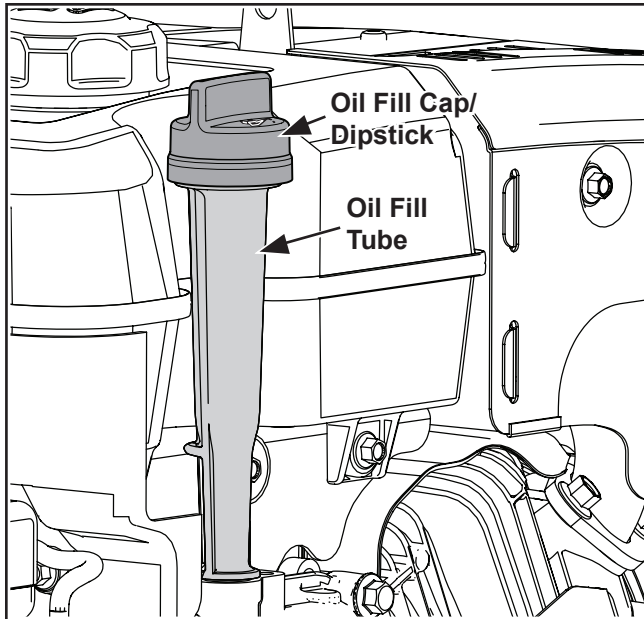

Figure 26. Oil Fill Cap/Dipstick and Oil Fill Tube.

3. Unscrew and remove the oil fill cap/dipstick; wipe off oil. Reinsert the dipstick into the oil fill tube and screw in.
4. Unscrew and remove the oil fill cap/dipstick and check that oil level is correct. The correct oil level is between the F and L marks on the dipstick. See Figure 27.

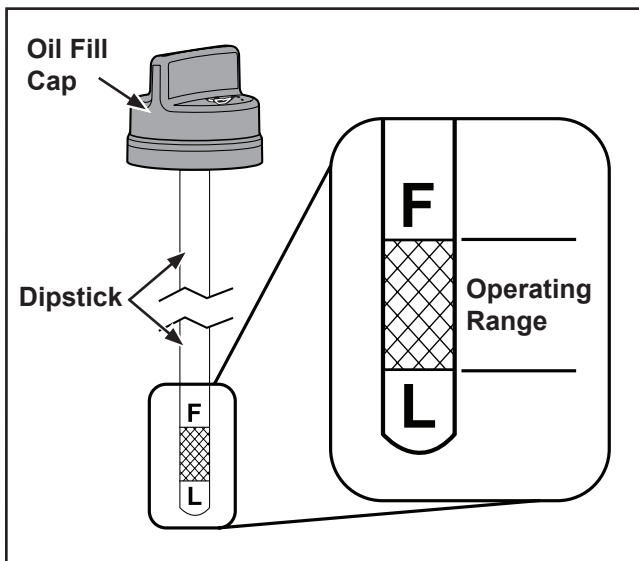

Figure 27. Correct Oil Level.

5. If the level is low, add oil of the proper type (refer to **Oil Recommendations**) and to the correct level. Always check the level before adding more oil.

NOTE: To prevent extensive engine wear or damage, always maintain the proper oil level in the crankcase. Never operate the engine with the oil level above or below the correct operating range.

6. Reinstall the oil fill cap/dipstick and tighten securely. See Figure 26.

Change Oil

For a new engine, change oil after the first 5 hours of operation. Thereafter, change oil yearly.

For an overhauled engine, use Kohler 5W-30 service class, SJ or higher oil for the first 5 hours of operation. Change the oil after this initial run-in period. Refill with service class SJ or higher oil as specified in the **Oil Viscosity Grades Table** (Figure 2).

Change the oil while the engine is still warm. The oil will flow freely and carry away more impurities. Make sure the engine is level when filling, checking, or changing the oil.

Change the oil as follows:

1. To keep snow, ice, etc., out of the engine, clean the area around the oil fill cap/dipstick before removing it. See Figure 26.
2. Remove the oil drain plug and the oil fill cap/dipstick. Allow ample time for complete drainage. See Figures 26 and 28.

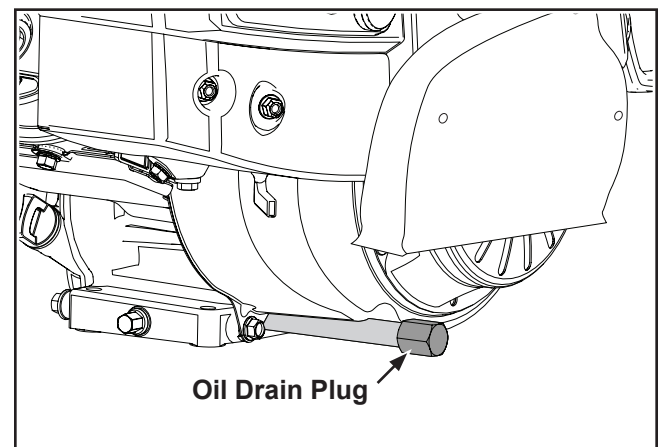

Figure 28. Oil Drain Plug Location.

3. Reinstall the oil drain plug and tighten to 9-13.5 N·m (80-120 in. lb.). See Figure 28.
4. Fill the crankcase, with new oil of the proper type. Refer to **Oil Recommendations**. Always check the level before adding more oil.

5. Reinstall the oil fill cap/dipstick and tighten securely. See Figure 26.

NOTE: To help protect the environment dispose of used oil in accordance with local ordinances.

Retractable Starter

To service the retractable starter, refer to the CH270 service manual. The retractable starter is similar to the CH270 in operation, though there are some visual differences. See Figure 29. To remove the retractable starter, removal of the air box cover, retractable starter cover, and engine cover is required.

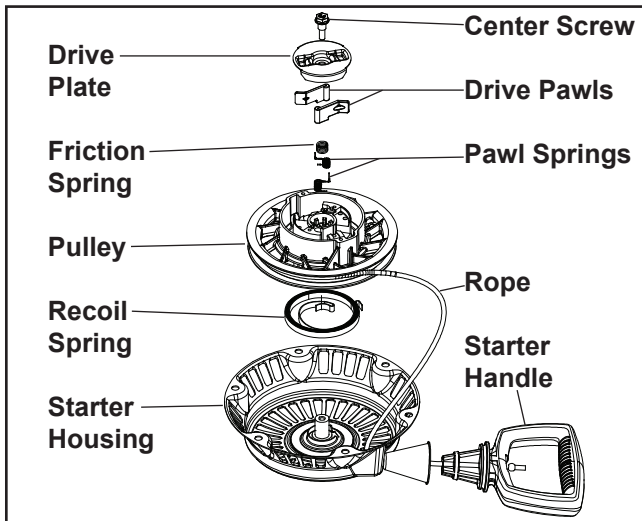

Figure 29. Retractable Starter - Exploded View.

Adjusting High Speed Stop Screw

1. Using a T25 drive, turn the screw to adjust high speed. See Figure 30 for the location of the high speed stop screw. **Do not** exceed 3750 RPM.



Figure 30. High Speed Stop Screw Location.

Breather Hose

The breather hose is inserted into the valve cover and positioned down along the valve cover. It does not connect to the air box. See Figure 31.

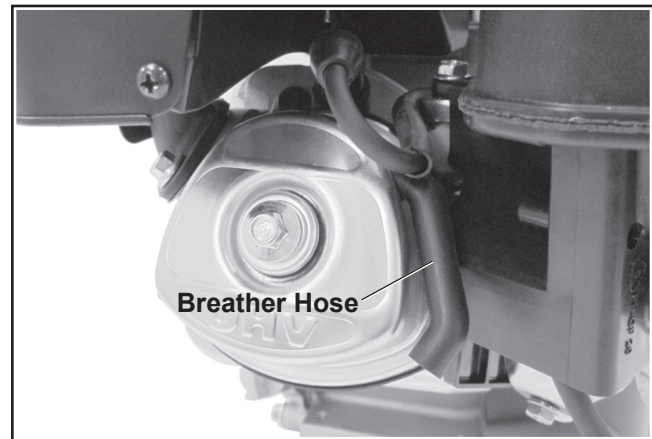

Figure 31. Breather Hose Orientation.

General Specifications¹

Gross Power (@ 3600 RPM, exceeds SAE J1940 HP Standards)	5.2 kW (7 HP)
Net Power (@ 3600 RPM, exceeds SAE J1940 HP Standards)	4.5 kW (6 HP)
Net Peak Torque (@ 2500 RPM)	11.8 N·m (8.7 ft. lb.)
Compression Ratio	8.2:1
Weight (Approximate)	17.2 kg (38.0 lb.)
Fuel Tank Capacity	3.2 L (3.4 U.S. qt.)

Air Box

Air Box Nut Torque	8 N·m (71 in. lb.)
Air Box Screw Torque	8 N·m (71 in. lb.)
Air Box Cover Nut Torque	4 N·m (35 in. lb.)

Dipstick Tube

Dipstick Tube Screw Torque	8 N·m (71 in. lb.)
----------------------------------	--------------------

Electric Starter

Electric Starter Screw Torque	24.4 N·m (216 in. lb.)
-------------------------------------	------------------------

Engine Control Assembly

Engine Control Assembly Screw Torque	24 N·m (213 in. lb.)
--	----------------------

Engine Cover

Engine Cover Shoulder Screw Torque	2.5 N·m (23 in. lb.)
Engine Extension Cover Screw Torque	8 N·m (71 in. lb.)

Fuel Tank

Fuel Tank Screw Torque	8 N·m (71 in. lb.)
------------------------------	--------------------

Governor Lever

Governor Lever Nut Torque	10 N·m (89 in. lb.)
---------------------------------	---------------------

Muffler

Muffler to Engine Control Assembly Nut Torque	24 N·m (213 in. lb.)
---	----------------------

Oil Drain Plug

Oil Drain Plug	9-13.5 N·m (80-120 in. lb.)
----------------------	-----------------------------

Retractable Starter

Retractable Starter Cover Screw Torque.....	5.4 N·m (48 in. lb.)
Retractable Starter Center Screw Torque.....	5.4 N·m (48 in. lb.)

Spark Plug

Spark Plug Type (Champion® or Equivalent)	XC12YC
Spark Plug Torque	24 N·m (18 ft. lb.)

¹Values are in Metric units. Values in parentheses are English equivalents. Lubricate threads with engine oil prior to assembly.

KOHLER[®] ENGINES

FOR SALES AND SERVICE INFORMATION
IN U.S. AND CANADA, CALL **1-800-544-2444**

KohlerEngines.com

ENGINE DIVISION, KOHLER CO., KOHLER, WISCONSIN 53044

© 2011 by Kohler Co. All rights reserved.

FORM NO.: 17 690 02 Rev. --
ISSUED: 1/11
REVISED:



1P17 690 02



8 85612 00701 8