

KOHLER ENGINES

SERVICE MANUAL

K331

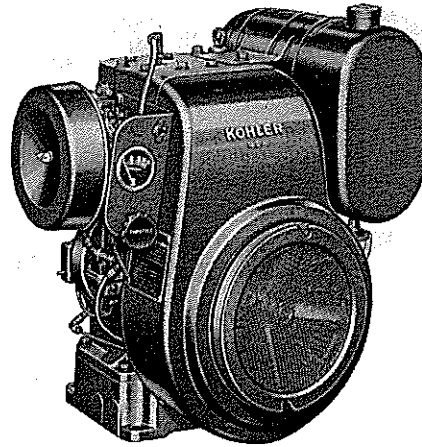

K 3 3 1

CONTENTS

	Page		Page
Operation Instructions.....	3	Reconditioning.....	9
Maintenance.....	3	Disassembly of Engine.....	9
Trouble Shooting.....	4	Inspection of Parts.....	9
Service Procedure.....	5	Assembly of Engine.....	10
Compression Check.....	5	Final Adjustments.....	14
Crankcase Vacuum Check.....	5	Clutch Models.....	14
Air Cleaner.....	5	Electric Starting.....	16
Fuel System.....	5	Gas - Gasoline System.....	18
Governor and Speed Control.....	7	Specifications.....	20
Ignition System.....	7	Tables.....	21

OPERATION INSTRUCTIONS

IMPORTANT

Before servicing a Kohler engine READ THIS MANUAL CAREFULLY and keep handy for reference.

Kohler engines are 4-cycle air-cooled. Engines are built under close inspection, tested under load and adjusted to meet rigid specifications before shipment is made from the factory.

General design—rugged heavy duty, cast iron block and base, modern short stroke, built-in mechanical governor.

This manual is designed to give Service Stations and owners information on proper care of all Kohler engines. Follow instructions carefully to insure trouble-free operation and long life.

1. Before Starting

- a. Remove oil filler cap and check oil level. Add clean oil to mark indicated on dipstick (SAE 30 in summer; SAE 10 in winter; SAE 5W, sub-zero). *Oil should not be over full mark.*

Engines with oil bath air cleaner

Remove cleaner cover and add oil until the level reaches the arrow marked on the air cleaner bowl.

- b. Fill the fuel tank with clean, fresh, gasoline of regular grade. **DO NOT MIX OIL WITH THE GASOLINE.** Be sure that fuel tank cap vent hole is open.
- c. If engine is equipped with a reduction gear unit, remove both plugs and add oil (same grade as used in crankcase) to oil level hole. Be sure that vent hole of oil fill plug is open.
- d. If engine is equipped with a clutch, remove inspection plate and fill with one pint SAE 10 oil to the oil level plug. Be sure vent hole in pipe plug located on top of clutch flange is open.

NOTE: Clutch on clutch reduction gear models is dry type.

2. To Start

- a. Open valve on the sediment bowl.
- b. Close choke lever. More or less choking may be necessary due to variations in temperature, grade of fuel, etc. Little or none will be needed when engine is warm. Experience will teach you the degree necessary under varying conditions. If engine is equipped with remote throttle control cable, open throttle about one-half way until engine starts, then set at desired speed.
- c. Wind cord around the starter pulley, give a quick steady pull. If a second pull is necessary, return choke to its original position. Do not jerk

or pull retractable starter to end of cable—return handle slowly. Pull so that cable is in straight line through guide. On engines where a hand crank is used—engine should start by giving engine one-half turn—it is not necessary to “spin” engine.

- d. Slowly return choke to its open position immediately after the engine has started.

3. To Stop

Whenever possible, it is recommended to remove the load and let engine idle before stopping.

- a. Press the breaker point “stop” button and *hold until engine is completely stopped.* On engines using a “start-stop” switch—push toggle to “stop” position.
- b. If engine is to be taken out of service for a considerable length of time—see instructions for storing.

4. Precautions

Stop engine before filling fuel tank. Avoid spilling gasoline on a hot engine. Always use fresh, clean gasoline.

- a. Avoid injuries. *Always disconnect spark plug cable before making any adjustments to the machine powered by the engine.*
- b. Be sure crankcase and air cleaner are properly serviced at all times. Dirt drawn through improperly serviced air cleaner can ruin an engine in a few hours. Always use fresh, clean oil.
- c. Let engine warm up before applying load.
- d. *Keep cylinder block, flywheel and cylinder head cooling fins and rotating air screen clean.* This is very important for proper cooling on air-cooled engines.
- e. Do not operate at speeds greater than governor setting or run continuously at maximum load.

MAINTENANCE

1. Each Day

Check the oil level. Add oil only as needed, keeping the level between the marks on the gauge.

Be sure that rotating screen is in proper position and clean. A bent screen will allow chaff and dirt to collect under the shroud and cause the engine to overheat.

2. Every 25 Operating Hours

- a. Change oil in the crankcase and air cleaner.

(Change more often under extremely dusty conditions.) Be sure there are no air leaks at gasket joints between air cleaner, carburetor and cylinder block.

b. Wipe oil and dirt from fins, shroud and baffles.

3. Every 100 Operating Hours

Make regular 25 hour inspection and in addition--

- a. Clean spark plug and reset gap to .025",
- b. Remove, clean and replace the sediment bowl.
- c. Check breaker points and reset to .020".
- d. Keep air intake area and cooling fins clean.
- e. If engine has recoil starter, oil periodically through hole as indicated on starter housing.

4. Instructions for Storing

If your engine is to be out of service for a considerable length of time the following procedure is recommended:

- a. Drain fuel tank.
- b. Drain carburetor by loosening nut on bottom of carburetor bowl, and retighten.
- c. Remove, clean, and replace sediment bowl.
- d. Clean exterior of engine.
- e. Spread a film of light oil over any exposed surfaces of engine subject to corrosion.
- f. Pour a tablespoon full of SAE 30 oil into spark plug hole and crank engine slowly by hand. Replace spark plug.
- g. Store in dry place.

TROUBLE SHOOTING

Following is a list of troubles which may occur from average use and normal wear.

1. Hard Starting

- a. Faulty ignition.
 - (1) Loose or grounded high tension or breaker point leads.
 - (2) Improper breaker point gap.
 - (3) Faulty spark plug.
 - (4) Faulty condenser or coil.
 - (5) Incorrect spark timing.
- b. Faulty carburetion.
 - (1) Gasoline not getting to carburetor.
 - (a) Dirt or gum in fuel line.
 - (b) Faulty fuel pump.
 - (2) Dirt in carburetor.
 - (3) Carburetor improperly adjusted.
- c. Compression loss.

(1) Valves leaking or sticking.

(2) Rings worn.

(3) Head gasket leaking.

2. Overheating

- a. Insufficient available cool air.
- b. Dirty air intake screen, shroud or cooling fins.
- c. Improper fuel.
- d. Fuel mixture too lean.
- e. Improper ignition timing.

3. Backfiring

- a. Fuel mixture too lean.
- b. Sticky intake valve.
- c. Improper timing.

4. Occasional Missing at High Speed

- a. Spark plug gap too wide.
- b. Improper carburetor setting or lack of fuel.
- c. Wrong type spark plug. Use recommended spark plug.
- d. Improper timing.

5. Missing Under Slow Hard Pull

- a. Spark plug gap too wide.
- b. Pitted breaker points.
- c. Partially fouled spark plug.
- d. Defective ignition cable.

6. Knocking

- a. Fuel octane rating too low.
- b. Overheated engine.
- c. Improper timing.
- d. Loose connecting rod.
- e. Excessive carbon in combustion chamber.

7. Operating Erratically

- a. Clogged fuel line.
- b. Water in fuel.
- c. Faulty choke control.
- d. Improper fuel mixture.
- e. Loose ignition system connections.
- f. Air leaks in manifold or carburetor connections.

8. Engine Will Not Idle

- a. Improper carburetor idling adjustment.
- b. Carburetor jets clogged.
- c. Spark plug gap too small.
- d. Leaking carburetor or manifold gaskets.
- e. Sticking or leaking valves.
- f. Weak coil or condenser.

SERVICE PROCEDURE

Whenever possible, discuss with the engine owner the type of application on which the engine is being used and the length of time it has been in service.

Inspect the engine in the owner's presence and try to determine, as nearly as possible, the extent of repairs necessary.

When an engine has been reconditioned, the owner has a right to expect the same performance that he would normally receive from a new engine. It is impossible to over-emphasize the importance of good service. Failure in this field discourages new sales.

If the service man will familiarize himself with the following instructions, he will have no difficulty with repair and maintenance of the K330/K331 engines.

COMPRESSION CHECK

A commercial compression testing gauge should be used in the manner indicated by its manufacturer. An engine in top condition will show compression of 110 to 120 psi.

When this figure falls below 100 psi it indicates leaking rings or valves or combustion chamber deposits which limit the charge entering the cylinder. See Reconditioning.

CRANKCASE VACUUM CHECK

The crankcase breather maintains a partial vacuum in the crankcase. It may be checked with a water U-tube manometer. Connect it to the crankcase through a tube and cork at the filler hole. A vacuum of 5 to 10 inches of water should be present when engine is running.

Lack of vacuum would indicate faulty breather, excessive engine blow-by, or leak of air into crankcase such as through a leaking oil seal. See Reconditioning.

AIR CLEANER

The air cleaner is one of the most important parts of the engine from the standpoint of engine life. If dirty air gets into the engine, it can wear out the piston rings in a few hours time.

An oil bath air cleaner should be cleaned and filled with fresh oil as often as dirt accumulation builds up in the sediment cup. The time will vary with air conditions.

Dry paper element type cleaners can be cleaned by removing element and tapping lightly, allowing loose dirt to fall off. The element cartridges should be replaced if dirt does not drop off easily. The paper elements should be handled gently to avoid puncturing

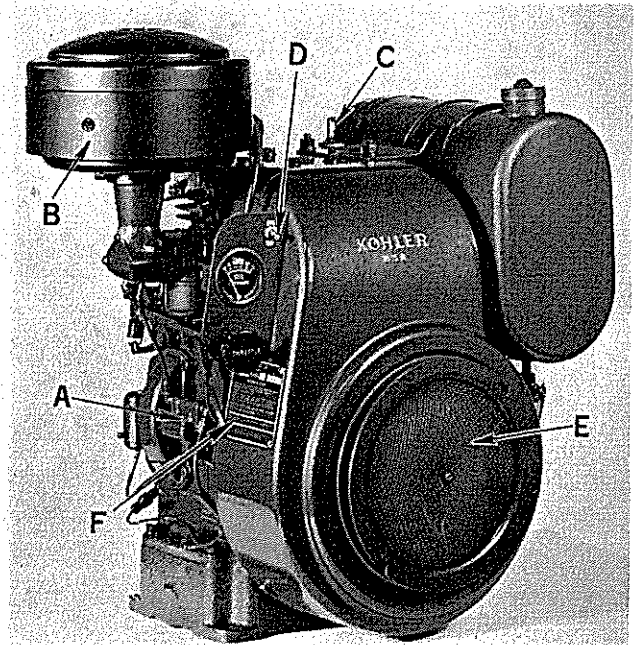

Figure 1

- | | |
|-----------------------------|-------------------------|
| A - Fuel Pump | D - "Start-Stop" Switch |
| B - Oil Bath Air Cleaner | E - Cooling Air Screen |
| C - Oil Filler and Dipstick | F - Name Plate |

them. They should not be washed in solvents, and blowing out with an air hose is apt to rupture the paper.

When the air cleaner is removed, cover air intake hole to prevent dirt from falling into air horn and carburetor. The gasket between the air horn and carburetor prevents air from entering there. The air cleaner must fit tightly so as to prevent air that has not gone through the air cleaner from entering the carburetor.

FUEL SYSTEM

The fuel system consists of gasoline storage tank, shut-off valve, sediment bowl, fuel line and connections, fuel pump and carburetor. Carburetors for electric plants and some other applications may have special features.

When replacing parts or a complete carburetor, be sure to check Parts Identification Section for correct carburetor part number.

Service difficulties with fuel system usually stem from improper carburetor adjustment or dirt in one of the components. If gum forms in the carburetor, it will be necessary to completely disassemble it for thorough cleaning.

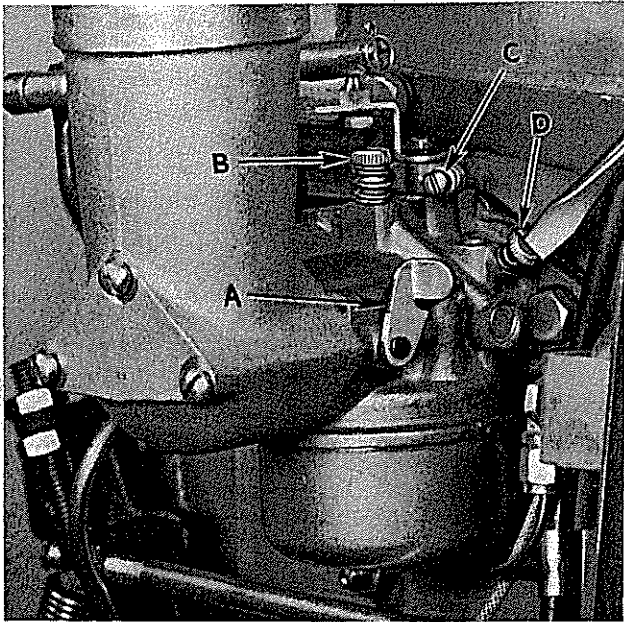

Figure 2

A - Choke Lever
 B - High Speed Adjustment Screw
 C - Idle Stop Screw
 D - Idle Adjustment Screw

1. Carburetor Adjustments

The carburetor is adjusted at the factory and under normal operating conditions will require no re-adjustments. In case adjustment is necessary, the following procedure is recommended:

- Turn high speed needle (B, Figure 2) counter-clockwise two turns (from closed position) and start engine.
- When engine reaches normal operating temperature, accelerate and check response. Operate engine under full load and adjust the high speed needle for the leanest mixture which will allow satisfactory acceleration and steady governor operation.
- If the engine misses and backfires, the high speed mixture is too lean. The high speed adjustment screw must be turned counter-clockwise $\frac{1}{4}$ turn at a time to correct this condition.
- If the engine shows sooty exhaust and is sluggish, the mixture is too rich. To correct, the high speed adjustment screw should be turned clockwise until smooth running is reached.
- To make final check of the high speed adjustment, operate under full load and make corrections necessary.
- Idle screw (D, Figure 2) adjustments should be made at the same time as the high speed adjustments, as each one affects the other.
- The final idle adjustment should be made at a speed not less than 1000 RPM until smoothest idling is obtained.

WARNING: Do not use force on the high speed needle or idle screw—they will be damaged.

2. Disassembly of Carburetor

- Remove carburetor from engine.
- Remove bowl nut, gasket and bowl.
- Remove float pin, float, needle and needle seat, check float for dents, leaks, and wear on float lip or in float pin holes.
- Remove bowl ring gasket.
- Remove low speed jet and high speed needle assembly and spring.
- Remove throttle valve screws, valve, shaft and lever assembly.
- Do not remove choke valve and shaft unless replacement of these parts is necessary.
- A spring loaded ball retains choke in wide-open position. **Caution**—hold a screw driver handle or small piece of wood over threaded hole in air horn (side opposite choke lever) to prevent the ball from flying out when shaft is removed.

3. Cleaning Carburetor Parts

- Clean all parts in gasoline or solvent. Gum is most easily removed with an alcohol or acetone solvent.
- Be sure any carbon deposits are removed from the bore, especially where throttle valve seats in casting.
- Blow out all passages with compressed air.
- Replace all worn and damaged parts. Always use new gaskets.

4. Assembly of Carburetor

- Install throttle shaft and valve. Valve must be installed with trademark "c" on side toward idle port when viewing from flange side.
- With valve screws loose and throttle lever set screw backed out, seat valve by tapping lightly with a small screwdriver. Hold in place while tightening screws.
- Install needle seat, needle, float and float pin.
- Set float level. With carburetor casting inverted, and float resting lightly against needle in its seat there should be $\frac{1}{64}$ " clearance between machined surface of casting and free end of float (side opposite needle seat).
- Adjust by bending lip of float with small screwdriver.
- Install bowl ring gasket, bowl nut gasket and bowl nut. Tighten securely after making sure bowl is centered on gasket.
- Install high speed needle assembly. Turn in until it seats in nozzle, then back out two turns.
- Install low speed jet and idle adjusting screw. Back out approximately $1\frac{1}{2}$ turns after seating lightly against jet. **Do not jam into seat as it will damage idle screw.**

5. Automatic Choke

A combination electric and thermostatic automatic choke is furnished on some applications, such as

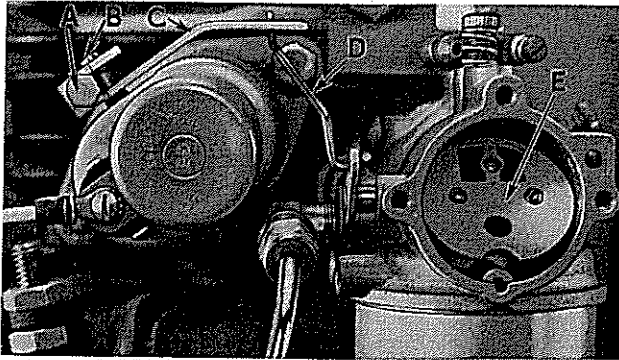

Figure 3
Automatic Choke

- A - Clamp Bolt
- B - Cross Shaft
- C - Choke Arm
- D - Linkage
- E - Choke Plate

electric plants. Readjustment of the choke is sometimes necessary to match local conditions. This is done by changing the position at which the choke arm (C) is clamped to the cross shaft (B) as shown in Figure 3, to allow more or less choking.

6. Fuel Pump

- a. To determine if the pump is working, disconnect the fuel line at the carburetor and use the priming lever to actuate the pump.
- b. Be sure all fuel lines are clear and the fittings are tight.
- c. If fuel pump fails to pump, it should be replaced.

GOVERNOR & SPEED CONTROL

Operating speed is determined by throttle control setting on engines so equipped. The governor maintains engine speed under varying loads and serves as a top speed limiting device. A stop is sometimes provided to prevent engine from exceeding recommended top speed.

Engines on some applications, such as electric plants, have constant speed settings as shown in Figure 4. The position at which the nuts (B) are clamped to the bracket as shown in Figure 3 determines the governor speed setting.

- a. Increasing the length of rod between the bracket and governor arm will *decrease* the speed. To *increase* speed, shorten this distance.
- b. Governor sensitivity may be adjusted by means of screw (A) in Figure 4. If too sensitive, speed surging may occur on change of load. A big drop in speed when load is applied indicates governor should be set for greater sensitivity. The speed setting screw must be readjusted after each change of the sensitivity.

Increasing the tension of the governor spring will give greater sensitivity; conversely, decreasing spring tension will allow broader governor action.

- c. The governor springs used on electric plant engines are usually different than those used on standard engines. Consult Parts Identification

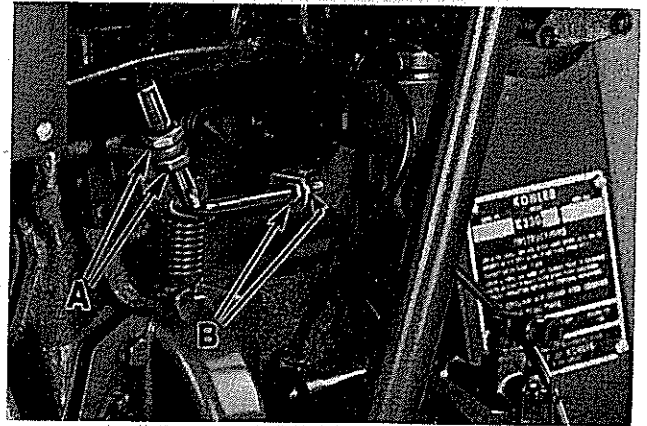

Figure 4
Governor Adjustment

- A - Sensitivity Adjustment
- B - Speed Adjustment

Section for correct part number if replacement is necessary.

IGNITION SYSTEM

1. Spark Plug

- a. Service periodically to reduce fouling. The deposits are hard to remove if allowed to remain longer than 100 operating hours.
- b. Degrease wet or oily plug and dry thoroughly.
- c. File electrode sparking areas to obtain bright, flat surfaces if blasting fails to clean plug properly.
- d. Set gap at .025.
- e. Install new or serviced spark plug with new gasket to recommended torque (27 ft. lbs).

2. Breaker Assembly

- a. Breaker points are operated by a cam on the engine camshaft.
- b. If contact points are dirty, they may be cleaned with a little gasoline. Wipe dry, but make sure no particles of lint or oily film are left between the point surfaces.
- c. If pitted or burned, the points should be replaced. See timing section for proper setting.
- d. If poor ignition persists, check condition of coil and condenser.

3. Testing Magneto

- a. Check magneto output by placing end of spark plug cable about 1/8" from the engine and crank at normal speed.
- b. If there is no spark, check breaker points.
- c. If necessary to test magneto coil, use a good commercial tester and refer to the testers instructions for the acceptance limits for various coils.

4. Testing Condenser

- a. Check condensers with a good commercial condenser tester.

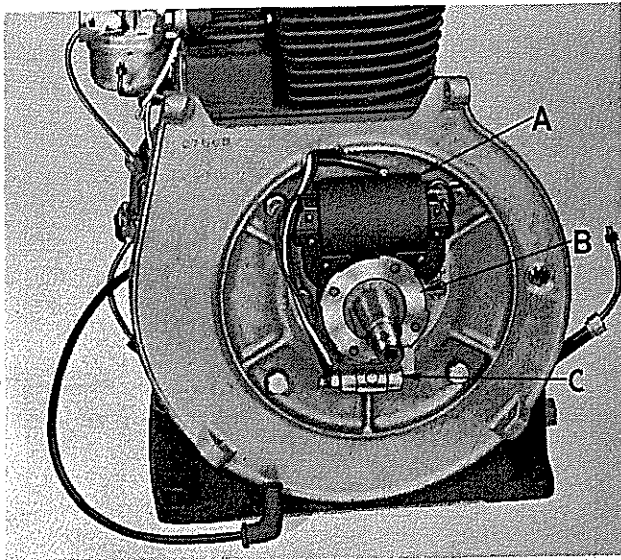

Figure 5
Bendix-Scintilla Magneto
A - Coil B - Rotating Magnet C - Condenser

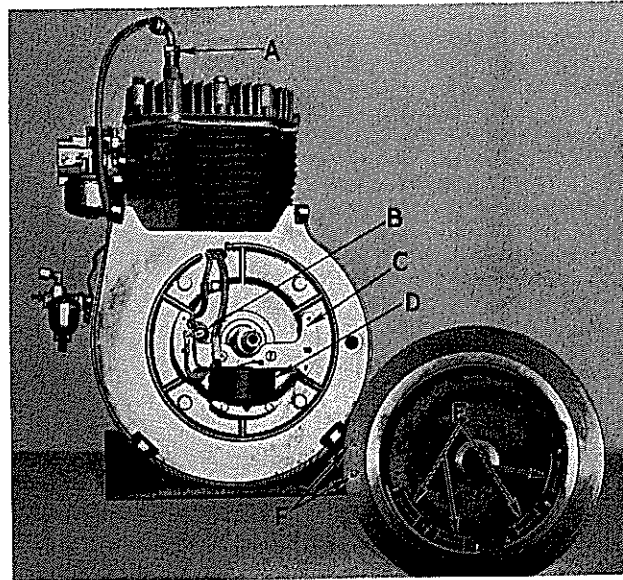

Figure 6
Phelon Magneto
A - Spark Plug (Shielded) D - Coil
B - Condenser E - Magnets
C - Stator F - Timing Marks

5. Bendix-Scintilla Magneto

- a. K330/K331 engines equipped with the Bendix-Scintilla magneto are as shown in Figure 5.
- b. The rotating magnet is mounted directly on the crankshaft.
- c. The crankshaft has one keyway for mounting the rotating magnet and the flywheel.

6. Phelon Magneto

- a. The Phelon magneto (Figure 6) differs from the Bendix-Scintilla magneto in that the magnets are mounted in the flywheel and the stator assembly is held in place on the bearing plate with cap screws.
- b. The two magnetos are not interchangeable because of crankshaft and bearing plate differences.

7. Ignition Timing

- a. All K330/K331 engines are equipped with a timing sight hole (A, Figure 8) in the bearing plate. Flywheels have two marks, visible through the sight hole. F, Figure 6.
- b. For precision ignition timing, adjust the breaker so that points begin to break when the second or "DC" mark on the flywheel appears in the sight hole when the flywheel is rotated in the direction of normal operation.
- c. If a timing light is available, set the breaker point gap while the engine is running so that the "SP" mark on the flywheel is centered in the sight hole. Figure 6.
- d. Point clearance should be approximately .020" fully opened. Clearance may vary a few thousandths to have exact timing. Such a variation is permissible.

Figure 7
Adjustment of Breaker Points

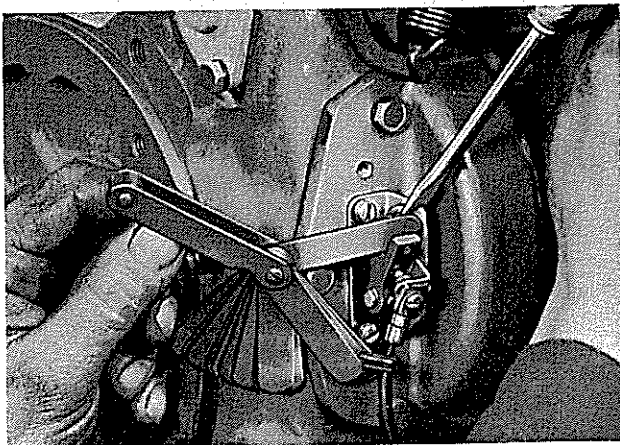
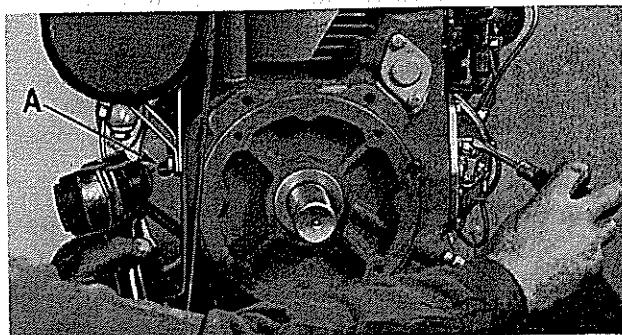

Figure 8
Adjusting Breaker Points Using Timing Light
A - Timing Sight Hole



RECONDITIONING

The following general disassembly procedure may prove to be of some assistance.

DISASSEMBLY OF ENGINE

1. Disconnect spark plug wire.
2. Close valve on sediment bowl and remove fuel line.
3. Remove air cleaner from carburetor intake.
4. Remove carburetor.
5. Remove fuel tank. Leave sediment bowl and nipple attached to tank.
6. Remove blower housing, cylinder baffle and head baffle.
7. Remove the rotating screen and starter pulley.

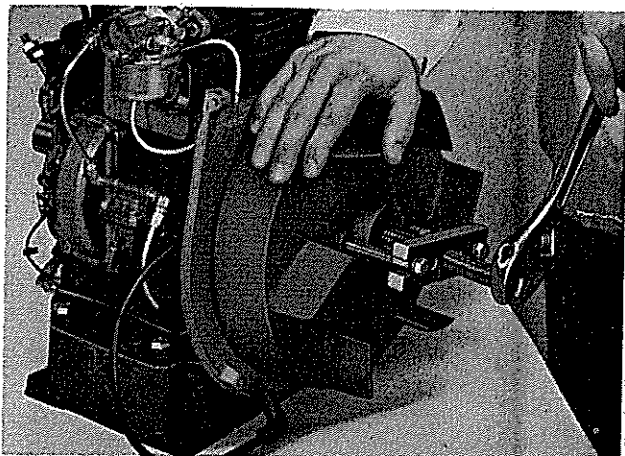

Figure 9
Removing Flywheel

8. The flywheel is mounted on a tapered shaft and can be removed without the use of special tools. If the flywheel does stick on the shaft, the use of a puller will prevent damage to the crankshaft threads (Figure 9).

Figure 10
Bearing Plate Removal

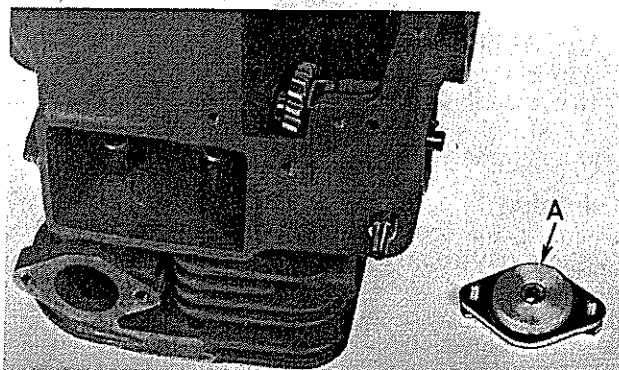
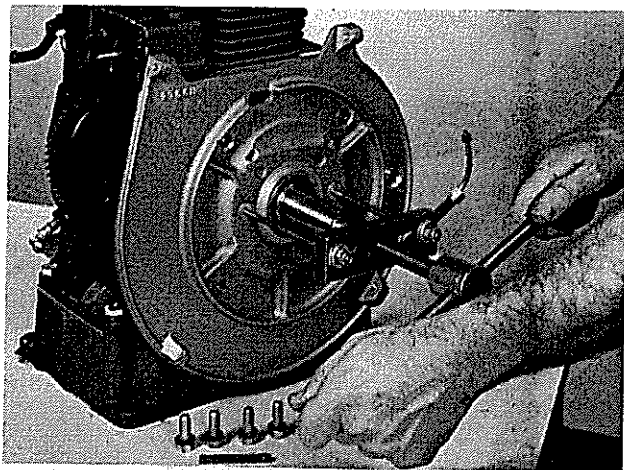

Figure 11
A - Governor Cover

9. Remove the breaker point cover, breaker point lead, breaker assembly and push rod.
10. Remove magneto plate and bearing plate.
11. Remove breather plate assembly.
12. Remove cylinder head. Clean deposits from combustion chamber and top of piston and block.
13. Remove valve spring retainers, springs and valves.
14. Remove oil base and disassemble connecting rod.
15. Remove the crankshaft oil seals and, if necessary, the main ball bearings.
16. **Governor Disassembly.**
 - a. Remove cover (A, Figure 11).
 - b. Remove governor assembly (B, Figure 14). The governor assembly is pressed into the block and can be removed by turning a cap screw into the end of the shaft and pulling directly on the cap screw.
 - c. Remove yoke (A, Figure 14). Unscrew by turning counter-clockwise.
 - d. Remove governor yoke shaft using a driver from end opposite governor control arm.

INSPECTION OF PARTS

1. After cleaning all parts, inspect them carefully to determine which ones are reusable.
2. **Reboring Cylinder Block.**
 - a. If badly scored, tapered, or out-of-round more than .005" the cylinder should be rebored.
 - b. Always hone or rebore to exactly .10", .20" or .030" over the standard bore size of 3.625".
 - c. Use an inside micrometer or dial gauge to determine cylinder wear before and during honing.
 - d. If honed to the nearest available oversizes mentioned above, oversize piston and ring assemblies can be used without any additional fitting, as proper clearances have been allowed.

- e. Any one of the commercial cylinder hones can be used with either a drill press or a portable electric drill. The drill press is preferable as it is important to keep the bore in alignment with the crankshaft crossbore.
- f. Finish by washing with soap and water. Cover the cylinder wall with oil to prevent rust.

3. Crankshaft.

- a. Check for score marks and metallic pick-up. Slight score marks can be cleaned up with crocus cloth soaked in oil.
- b. With a micrometer, check the journals for out-of-roundness. If out-of-round, replace the shaft or have crank pin reground to .010" or .020" undersize.
- c. Check gear, keyway, and tapered part of shaft for wear. If either taper or keyway is worn, replace the shaft.

4. Connecting Rod.

- a. Check for wear, score marks, running clearance, and side clearance. Replace it if worn beyond high limit of clearances shown in table on page 16.
- b. Undersize bearings .002" less than standard are available for cases of moderate wear. Bearings .010" and .020" less than standard are available where grinding of the crankpin is necessary.

5. Piston.

- a. If the cylinder block does not need reboring, and the old piston is free of score and scuff marks, check the piston ring grooves and lands.
- b. Clean up the grooves and fit new rings.
- c. With rings in place, check with a feeler gauge. If a .005" feeler can be inserted between ring and land, replace the piston.
- d. Piston ring and clearance should be from .007" to .017".
- e. Never re-use old rings.

6. Piston Pins.

- a. Very little wear takes place on the piston pin or in the piston bosses.
- b. If it is necessary to replace the connecting rod, due to wear at the large end of the rod, it is advisable to install a new piston pin.
- c. Oversize pins are not available.
- d. After assembly of piston to connecting rod, align rod so piston will be square with cylinder bore and crankshaft using a commercial rod aligner.

7. Valves, Seats and Guides.

- a. Check the clearance of old valve stems in the guides.
- b. If worn, replace guides and install new valves. Consult Parts Identification Section for correct valve number. Some applications require hard-faced valves.
- c. Intake valve seat is normally machined into the block. Separate inserts are sometimes used.

- d. The exhaust valve seat is a moly-nickel-chrome heat-treated insert.
- e. The seating surfaces should be held as nearly as possible to 1/32" in width. Seats with more than 1/16" seating surface should be reconditioned with 45° and 15° cutters and then ground to form the proper seat.

8. Valve Springs.

- a. Proper valve spring strength is important on a high speed engine such as the K330/K331.
- b. Check old springs for length. Length of exhaust valve spring 1 3/16". Length of intake valve spring 2 1/4".

ASSEMBLY OF ENGINE

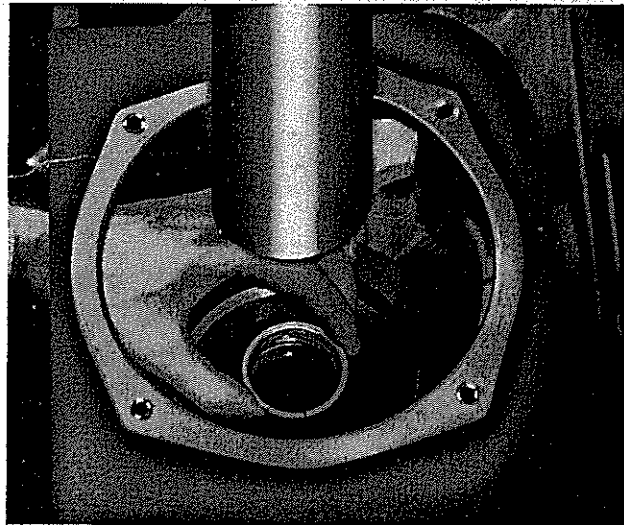

Figure 12
Pressing in Transfer Sleeve

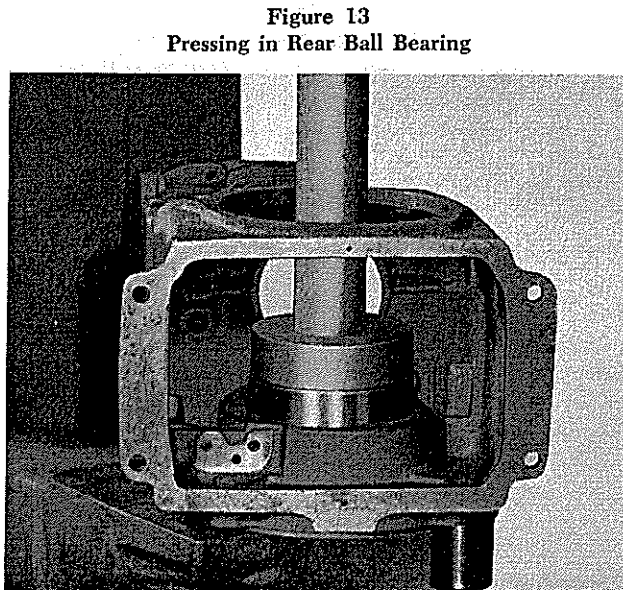

Figure 13
Pressing in Rear Ball Bearing

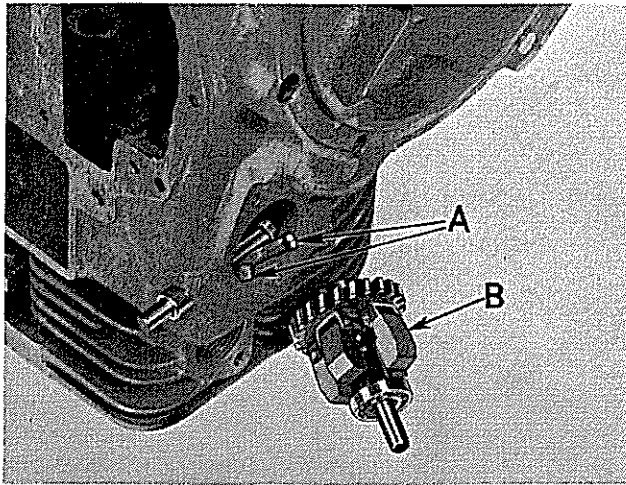

Figure 14
Assembling Governor

A - Governor Yoke B - Governor Assembly

1. Transfer Sleeve and Rear Main Bearing.

- a. With arbor press or close fitting pilot, press or drive oil transfer sleeve into crankcase (Figure 12). *Be sure oil holes in transfer sleeve and block line up.*
- b. The ball bearing, with shielded side toward inside of cylinder block, is then pressed into the block. (Figure 13).

2. Governor.

- a. The first step in governor assembly installation is the insertion of the two needle bearings which support the governor yoke shaft in the cylinder block assembly. (See Figure 14).
- b. Drive the closed needle bearing into position with governor yoke shaft.
- c. Drive the open needle bearing into place. (Figure 14). The drilled and tapped hole in the governor yoke shaft must be in the exact center of the governor hole opening.
- d. Turn the yoke into the governor yoke shaft.
- e. Insert the governor assembly (B, Figure 14) into the governor opening so as to guide the governor shaft in a perfectly centered position.
- f. Turn a cap screw into the end of the governor shaft to protect it. Drive the governor assembly into place by striking the cap screw.
- g. The two protrusions on the governor yoke (A, Figure 14) must be perfectly aligned with the outer race of the ball bearing. If the yoke rides to one side of the outer race, it will be necessary to shift the governor yoke shaft bushings so that proper contact is made.

3. Breaker Cam on Camshaft.

- a. Before installing the camshaft assembly in the block, insert the breaker cam between the springs of the spark advance system as shown in Figure 15.

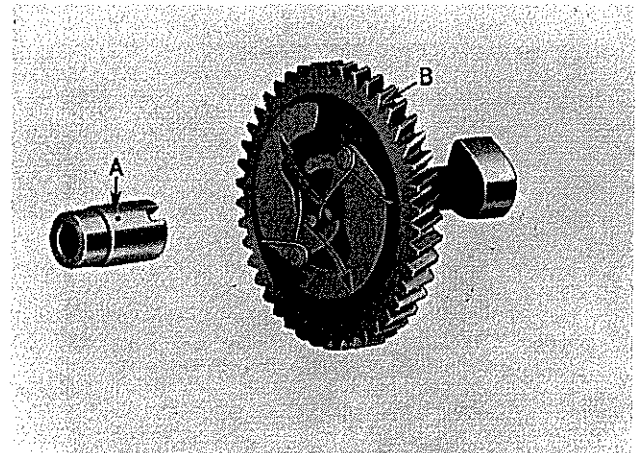

Figure 15

A - Ignition Cam Timing Mark
B - Camshaft Gear Timing Mark

- b. Spread the springs in the direction indicated by the arrows and insert the cam.
- c. Spark timing marks (A and B, Figure 15) on the cam and spark-advance side of the camshaft gear must coincide.

4. Valve Tappets and Camshaft.

- a. Turn cylinder block upside down and place the valve tappets in the tappet guides. Press in new valve guides if replacements are required.
- b. Hold the camshaft assembly in position shown (Figure 16) and slide the camshaft pin through from the bearing plate side and press into the power take-off side of the block.

Figure 16
Pressing in Camshaft Pin

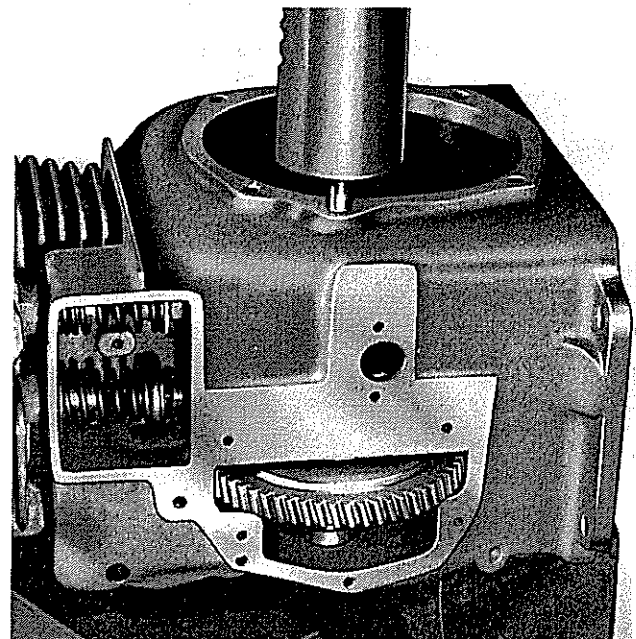

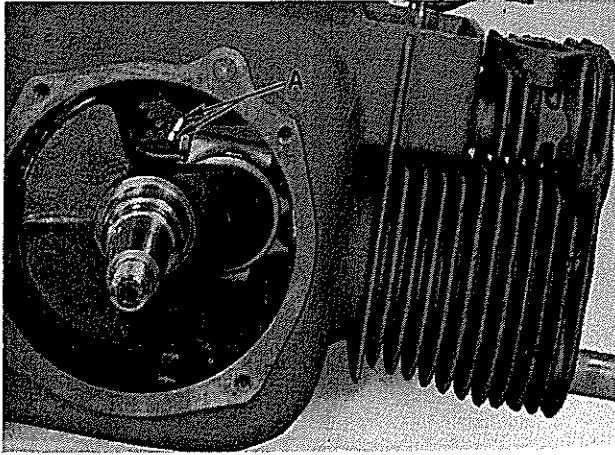

Figure 17

A - Camshaft and Crankshaft Timing Marks

- c. Camshaft end clearance should be .005" to .010". If end play exceeds this amount, a washer can be used to decrease it. Washer .005" thick is part No. 275066 and .010" washer is part No. 275067.

5. Crankshaft Magneto Plate.

- a. Timing marks are provided on crankshaft and camshaft gears to correctly time the engine (Figure 17). The mark on a tooth of the camshaft gear must line up with mark on the shoulder of the crankshaft gear after the crankshaft is in place.
- b. Press the ball bearing, with shielded side toward inside of cylinder block, into the magneto plate.
- c. Press crankshaft into rear main bearing and press bearing plate and front oil seal on the

Figure 18

Installing Crankshaft and Bearing Plate

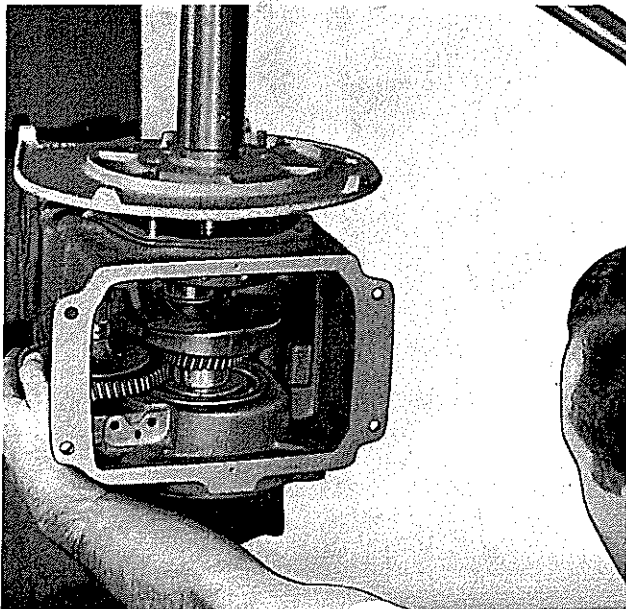

crankshaft simultaneously (Figure 18). Be careful to avoid bending the crankshaft. Be sure the oil seal lip is not damaged during assembly.

- d. After the front main bearing, crankshaft and magneto plate are installed, check the crankshaft end play. This may vary from .003" to .008" and is checked between the crankshaft gear and the ball bearing. Spacer gaskets are available in .005" and .010" sizes.

6. Piston and Rod Assembly.

- a. Assemble the piston to the connecting rod and secure piston pin with retainers. Always use *new* retainers. Be sure retainers are fully engaged in grooves in the piston pin bosses.
- b. Before putting rings on the piston, try them in the cylinder bore to be sure they have a clearance of from .007" to .017".
- c. Rings must be installed according to the marking on the ring. Compression rings must be installed with the groove or bevel *up* when on the *inside* of the ring or *down* when the groove bevel is on the *outside* of the ring. Oil control rings can be installed either way. Proper installation of rings is vital to their correct functioning.
- d. After rings are installed in their proper grooves, oil the complete assembly, space the ring gaps so they are not in line and insert into the cylinder bore. Use a ring compressor to prevent ring breakage during installation.

7. Attaching Rod to Crankshaft.

- a. Oil connecting rod bearing and crank pin.
- b. *It is important that the marks on the connecting rod and cap line up and face flywheel end of engine.*
- c. Connecting rod cap, screw lock and cap screws are then loosely attached to connecting rod.
- d. Tighten cap screws with a torque wrench to 40 ft. pounds. Back off screws and retighten to 35 ft. pounds. This will assure a tight fit of the rod to the crankshaft and avoids the possibility that screws may be tight in the threads while rod is still slightly loose on the shaft.

8. Oil Pump.

- a. The oil pump is positive gear type. Pressure is adjusted at the factory and it should not be necessary to change this adjustment.
- b. A sudden drop in oil pressure may be caused by dirt or foreign particles in the pump. By removing the oil line fitting from the outside of the cylinder block, compressed air can be forced into the pump to loosen up working parts and remove any foreign material.
- c. If it should be necessary to re-adjust oil pressure, turn screw to left to decrease pressure and to right to increase pressure. Seal the screw with Permatex or equivalent when adjustment is completed.
- d. When the oil pump is installed, the oil pump drive gear should be checked for backlash and for alignment with the cam gear.

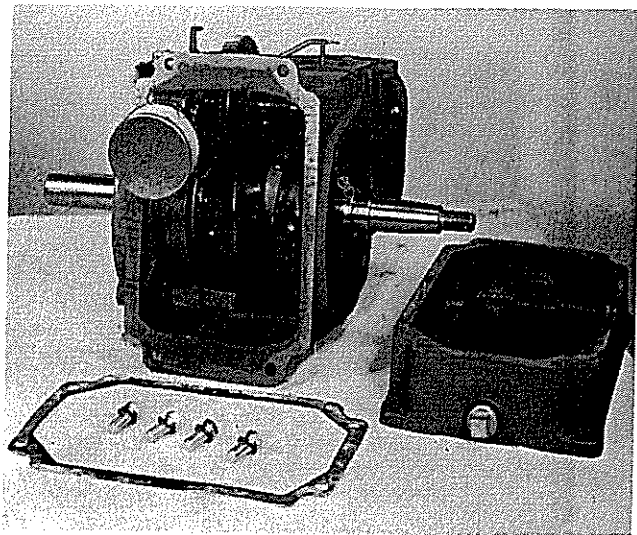

Figure 19

9. Oil Base.

- a. Assemble oil base to block with four screws (Figure 19).
- b. It is important that a new gasket be used to prevent oil leakage.

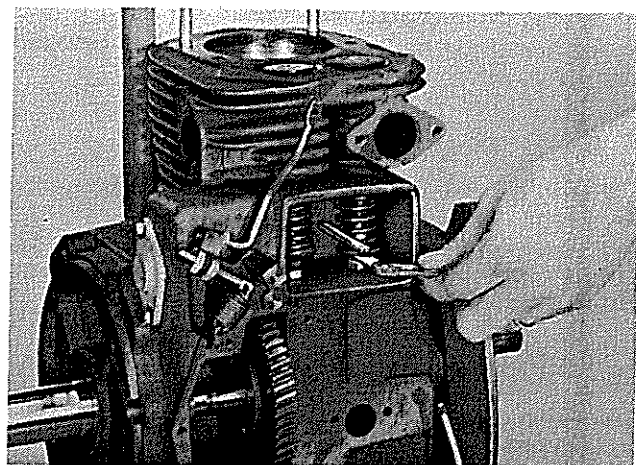

Figure 20
Checking Valve Clearance

10. Installing and Adjusting Valves.

- a. Install valve springs, spring retainers and valves.
- b. Using a valve spring compressor, compress the valve springs and install the valve keys.
- c. Be sure valves are firmly seated in block and adjust clearance (Figure 20). Set exhaust to .020", intake to .008"—both adjustments to be made when engine is at top dead center.

11. Breather Assembly.

- a. The correct order of breather assembly is as follows: (Figure 21).
Gasket, plate and reed (small drilled hole must

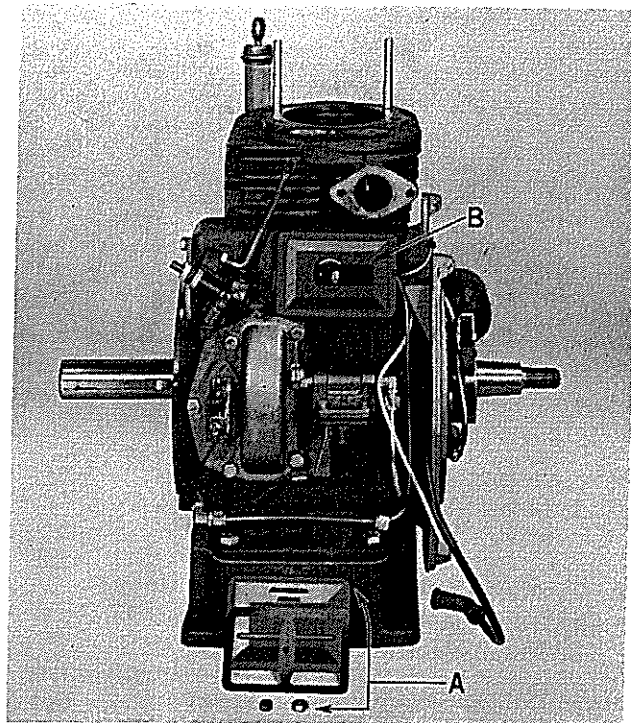

Figure 21

A - Cover and Nut B - Plate and Reed

- be at bottom of plate), gasket, rubber spacer and cover (vent slots must be at top of cover).
- b. The reed type breather valve maintains a slight vacuum in the engine crankcase. All parts must be clean and in good condition. Replace any part if necessary.
- c. Be sure cover is tight to prevent oil leaks.

12. Gear Cover.

- a. Use new gasket and bolt cover with five screws to engine block.
- b. Be certain gasket is properly aligned to prevent oil leaks.

13. Breaker Points.

- a. Install push rod.
- b. Screw breaker in place with two screws.
- c. Attach magneto lead.
- d. Set breaker gap at .020". For precise setting see Ignition Section, page 5.

14. Carburetor.

- a. Using new gasket, bolt carburetor to air intake port with two screws.
- b. Attach air horn, including new gasket, with three screws.
- c. See section on carburetor adjustment for correct setting.

15. Fuel Pump.

- a. Using new gasket, bolt fuel pump to block.
- b. Connect one fuel line to pump and carburetor.

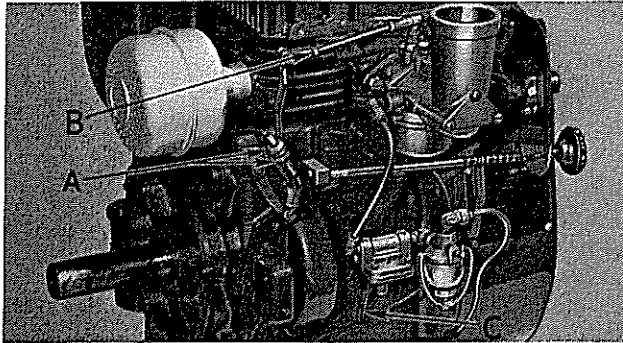

Figure 22

A - Gov. Sensitivity Adjustment B - Carburetor Linkage
C - Priming Lever

- c. Connect second line to pump and fuel tank.
- d. Make certain all connections are tight. An air leak will cause trouble.

16. Throttle Control and Governor Linkage.

- a. Insert oil seal over governor control shaft.
- b. Install throttle control (Figure 22).
- c. Install carburetor linkage (B, Figure 22). Length of the linkage should be adjusted so that travel of the governor arm matches the travel of the carburetor throttle arm.
- d. Governed speed is adjusted by throttle control position on variable speed engines (Figure 22). On constant speed applications, speed control is set in a fixed position (Figure 4).

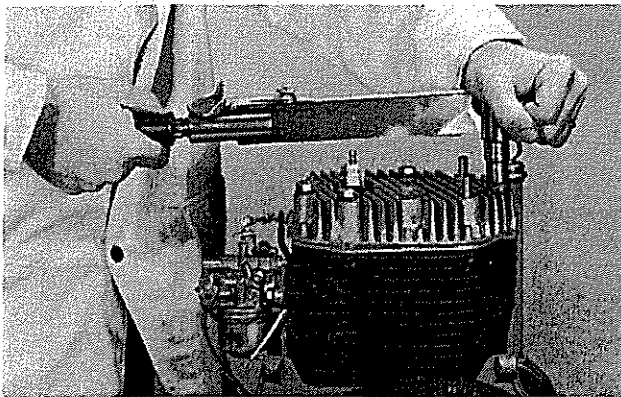

Figure 23

Tightening Cylinder Head Cap Screws

17. Cylinder Head.

- a. Always use a new head gasket when head has been removed for service work. It is recommended that head gasket be soaked in water before assembly.
- b. Check cylinder head on face plate to be sure gasket surface will make good contact at all points.
- c. It is important that head screws be tightened evenly, and in steps until 40 ft. pounds torque is reached (Figure 23).

18. Magneto.

- a. Figure 5 shows the Bendix-Scintilla magneto in position. Note how the breaker lead and high tension spark plug cable are pulled through the plate opening.
- b. After the magneto assembly has been bolted to the magneto plate, the rotating magnet is pressed on the crankshaft.

19. Flywheel.

- a. Place the wave washer on crankshaft and place the flywheel on shaft. The same key holds the Bendix-Scintilla magneto magnet and the flywheel.

Engines using the Phelon magneto have the stator assembly mounted on the bearing plate. The magnets are installed in the flywheel and charged at the factory. If replacement should ever become necessary the complete flywheel assembly should be replaced.

- b. Install starter pulley and lock washer. Insert a bar between the flywheel fins and tighten the holding nut until 100 ft. pounds torque is reached.

20. Blower Housing and Fuel Tank.

- a. The engine is now ready for the blower housing, cylinder baffles and head baffles.
- b. Install gas tank and connect fuel line between fuel filter and fuel pump.

FINAL ADJUSTMENTS

1. Refer to the starting instructions in the front of this section.
2. Follow the instructions in the front under Service Procedure for the final adjustment of Ignition, Carburetion, Governor, and Speed Control.

CLUTCH MODELS

- a. The clutch on this engine is a *wet disc* type running in oil. Before operating the unit, remove inspection plate (Figure 24) and fill the clutch to the level hole on the housing with one pint S.A.E. No. 10 oil.
- b. The clutch is vented through the pipe plug at the top of the housing. Check daily to see that hole is open.
- c. Change oil in clutch every 50 operating hours.

1. Clutch Adjustment

A firm pressure should be required to engage clutch at all times. If clutch shows evidence of slipping or overheating, proceed to readjust it.

- a. Remove inspection plate and locate adjustment lock by turning the engine over.
- b. Release clutch and with a large screw driver (Fig. 24) turn the collar clockwise one notch at a time until a firm pressure is required on the engaging handle.

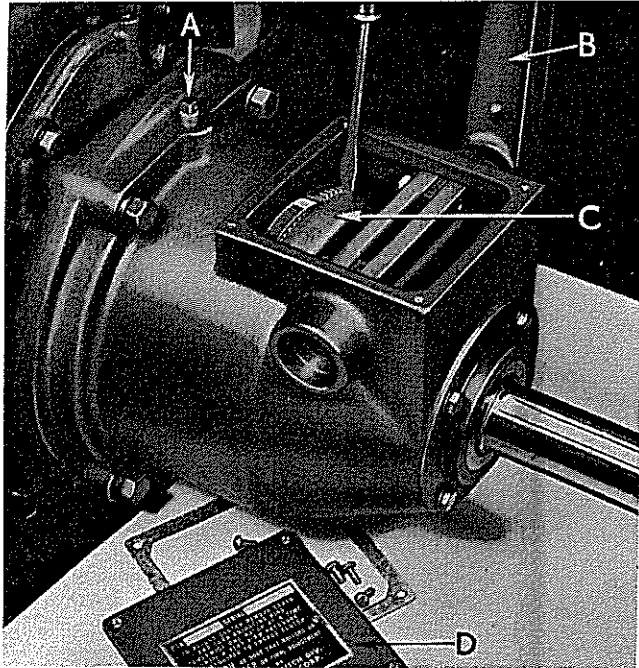

Figure 24

Adjusting Clutch

- | | |
|------------------|----------------------|
| A - Vent Plug | C - Adjusting Collar |
| B - Clutch Lever | D - Cover Plate |

- c. Be sure the rollers go over center on final engagement to lock the unit, or the clutch will release under load.

2. Service on Clutch

- a. Drain oil and remove cover plate.
- b. Remove the two cap screws from clutch yoke taking out the spacers.
- c. Pull out the clutch cross shaft.
- d. Remove the four bolts from the housing and slide the housing off.
- e. Loosen the bolts that clamp the clutch unit to the crankshaft and remove the locking screw.
- f. Pull the clutch unit off the engine crankshaft.
- g. If clutch plate replacement is necessary, simply unscrew the adjustment collar and remove the plate.
- h. Reverse procedure for reassembly and see adjustment section for proper clutch setting.
- i. Fill with one pint No. 10 oil and replace inspection plate before operating engine.

3. Clutch-Reduction Gear

- a. The clutch is a *dry disc* type, lever operated. (See Clutch Section for adjustment.)
- b. The reduction unit is a chain and sprocket type running in oil. (Fig. 25).
- c. Before operating engine, fill the gear housing to the oil level hole on the side of the gear box, three pints of oil (same grade as used in engine) will be required.
- d. Lubricate the clutch bearing collar through the plate in the housing every 50 operating hours.

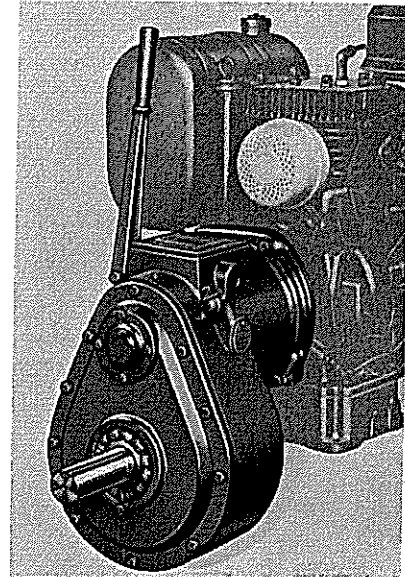
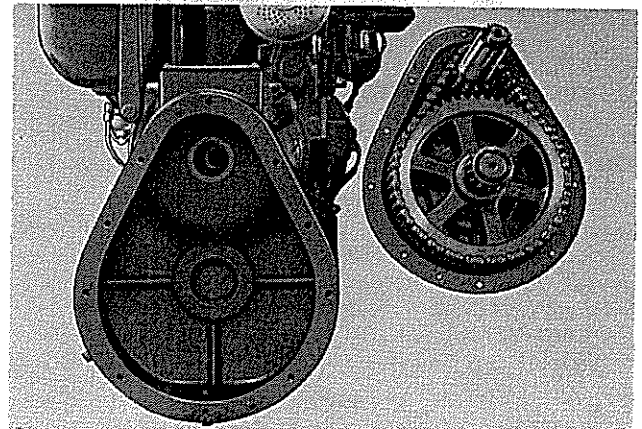

Figure 25
Clutch-Reduction Assembly

4. Service on Clutch-Reduction

- a. Service information on regular clutch model engines will apply with one exception: the *clutch-only unit is a wet type, running in oil; and the clutch-reduction equipped engine is a dry disc type clutch.*
- b. The reduction unit can be removed as an assembly by taking out the nine cap screws in the cover plate.
- c. The upper shaft is splined into the clutch unit and has its outer bearing in the housing cover.
- d. The lower shaft and sprocket uses tapered roller bearings. The bearing is pressed on the shaft and the bearing case is located in the rear of the housing. The outer bearing is equipped with an adjustable collar to adjust the shaft end clearance. (Fig. 26)
- e. Power-take-off shaft end clearance should be .0015 to .003. Lock the collar in place after adjustment is made with the $\frac{5}{16}$ cap screw.

Figure 26
Clutch-Reduction Assembly



ELECTRIC STARTING

A 12-volt Delco-Remy negative ground starter-generator unit is provided for electric starting. The starter-generator is pulley-belt driven from front or flywheel end of engine.

The starter-generator unit will function as a cranking motor when starter button is engaged. When engine is operating and starter switch is open, unit will function as a generator. A voltage regulator is mounted on unit and controls current and voltage to battery at all engine speeds.

1. Service on 12-Volt Electric Starting

Periodic maintenance should include:

- After 100 hours of operation lubricate ball bearings at both drive and commutator ends with 8 to 10 drops of light engine oil applied through hinge caps.
- Inspect commutator brushes after 200 hours of operation. Brushes should be replaced if they are less than one-half inch in length.
- Inspect regulator shock mounting grommets for freedom of movement and for breakage.
- Check mounting brackets and drive belt for proper tension.
- Be sure all electrical leads are in good condition and connections are tight.

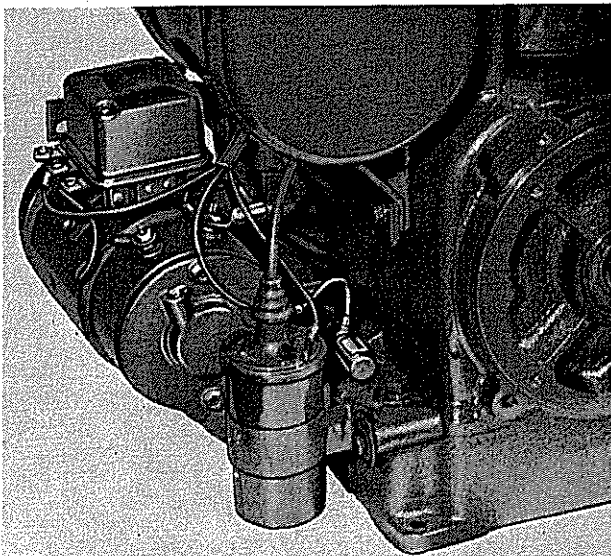

Figure 27
Starter-Generator Assembly Showing Regulator, Coil, and Condenser.

2. Regulator

The current voltage regulator used with combination starter generator unit is automatic in its control of current and voltage to battery.

Regulator Adjustments

Many cases of regulator trouble can be eliminated by a simple cleaning of the contact points plus some possible readjustment. The flat point always develops a slight cavity and is the point

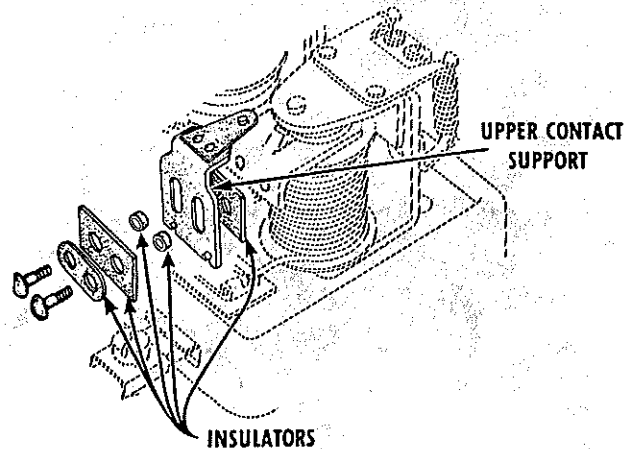

Figure 28
Disassembly of upper contact support for cleaning or replacement.

that requires the most attention. It is not necessary to have a perfectly flat surface on this point, but cleaning the surface down to pure metal with a fine cut riffel file will insure long periods of service without difficulty. The file should not be allowed to become greasy and should not be used to file other metals. After filing wipe points with lintless cloth, saturated in carbon tetrachloride to insure clean surfaces.

Caution: Never use emery cloth or sandpaper to clean the contact points.

Note: The flat point is in the armature. Clean them by loosening the upper contact support and moving it to one side. See Figure 28.

The cutout relay requires three checks and adjustments: air gap, point opening, and closing voltage. The air gap and point opening adjustments are made with the battery disconnected.

Air Gap: Place your fingers on the armature directly above the core, and press the armature down until the points just close. Then measure the air gap between the armature and the center of the core. Figure 29. The air gap should be .020. Adjust by raising or lowering the armature at its hinge mounting. Retighten screws after adjustment:

Point Opening: Adjust the point opening by bending the armature stop as shown in the Figure 30. The opening should be .020.

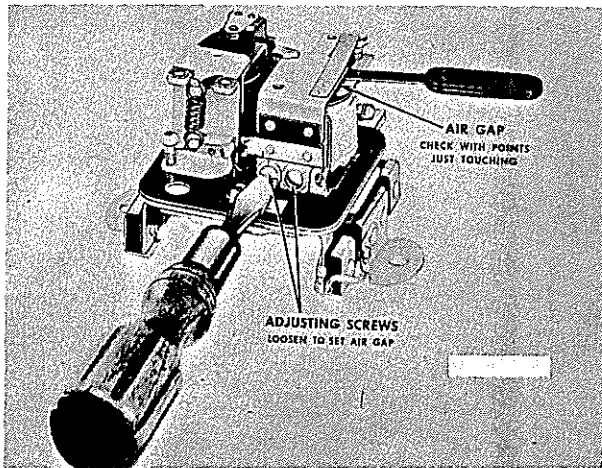

Figure 29

Cutout relay air gap check and adjustment. Battery must be disconnected when this check is made.

Closing Voltage: Adjust the closing voltage by turning the screw clockwise to increase spring tension and voltage, counter clockwise to decrease spring tension and closing voltage. See Figure 31. Be sure that closing voltage adjustment is at least 0.5 volt less than the current voltage regulator unit setting. This should be 12.8 volts.

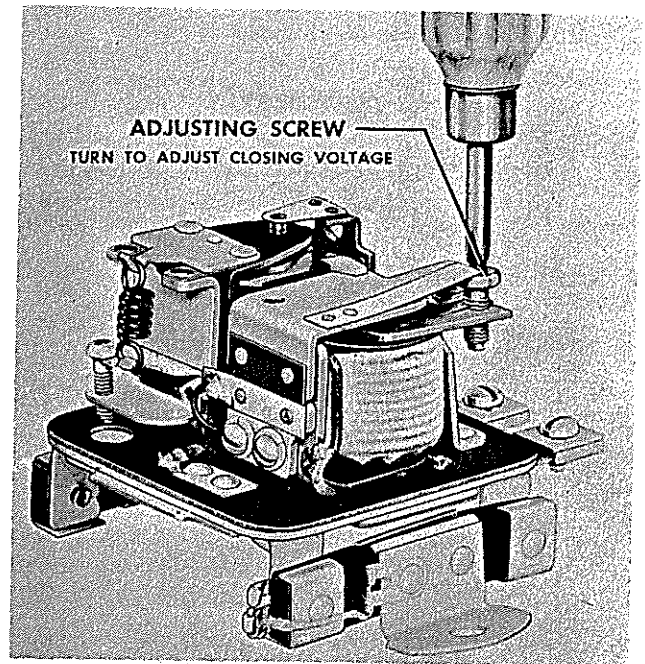

Figure 31

Adjustment of cutout relay closing voltage.

This should be .075". Adjust by loosening contact mounting screws and raising or lowering the contact bracket as required. Be sure the points are lined up and the screws are retightened after adjustment and before resetting the voltage setting. See Figure 32.

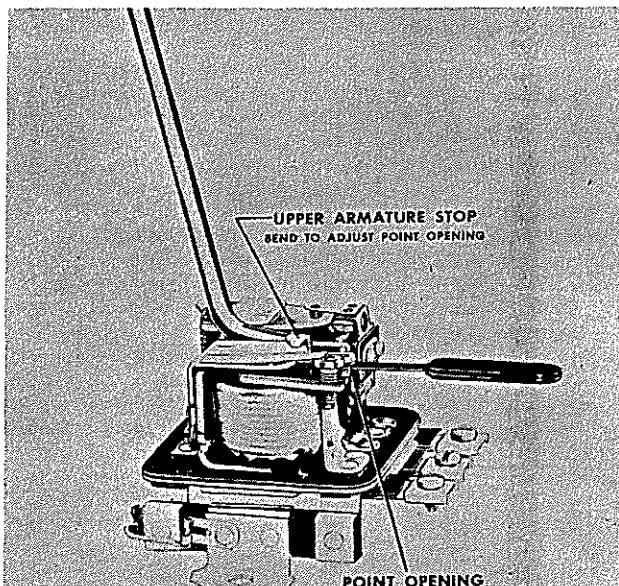

Figure 30

Cutout relay point opening check and adjustment. Battery must be disconnected when this check is made.

The current voltage regulator unit requires two inspections and adjustments: the armature air gap and the voltage setting.

Armature Air Gap: To check the air gap, push the armature down until contact points are still just touching then measure the air gap.

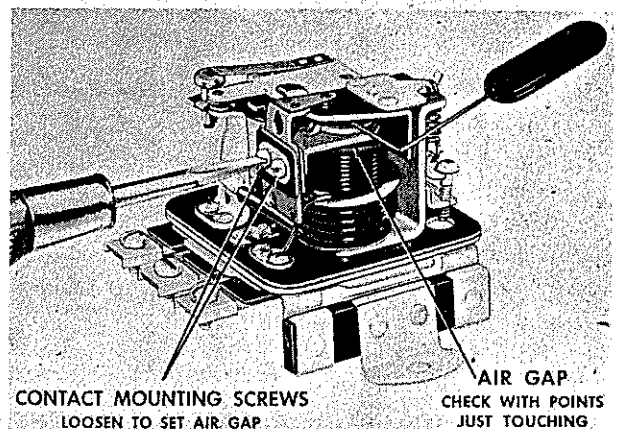

Figure 32

Current-voltage unit air gap check and adjustment.

Voltage Setting: Adjust the voltage setting by turning the adjusting screw—clockwise to increase the voltage setting and counter clockwise to decrease the voltage setting. After each adjustment, replace cover and allow ample running time to again stabilize voltage and temperature before rechecking the voltage setting. See Figure 33.

Caution: If the adjusting screw is turned down (clockwise) beyond the normal range required for adjustment, the spring support may fail to return when the pressure is relieved. If this happens, turn the screw counter clockwise until enough clearance develops between the screw head and the spring support. Then bend the spring support upward carefully with a small pliers until contact is made with the screw head. The final setting should always be approached by increasing the spring tension. In other words, if the setting is too high, the unit should be adjusted below the required value then raised to the exact setting by increasing the spring tension. Be sure the screw is exerting force on the hanger.

When the current voltage unit is badly out of adjustment or requires spring replacement the following procedures must be followed: Replacing the regulator spring requires care to prevent bending or distorting the spring support or the armature hinge. Preferably the spring should be hooked at the lower end first then stretched up with a screw driver blade or other

suitable tool, inserted between the turns until the upper end of the spring can be hooked.

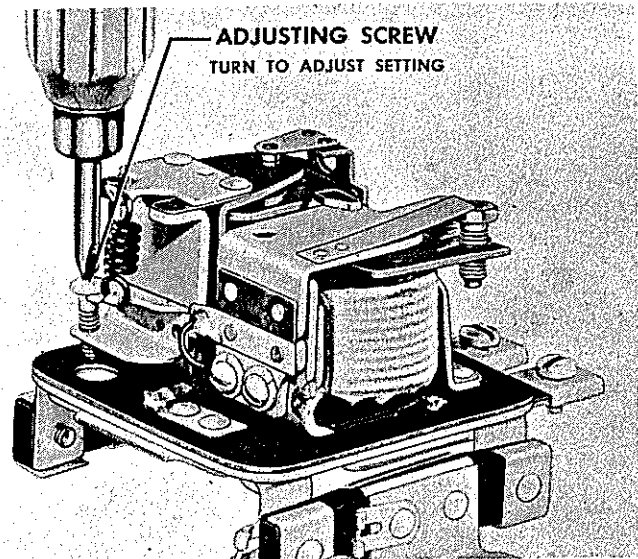
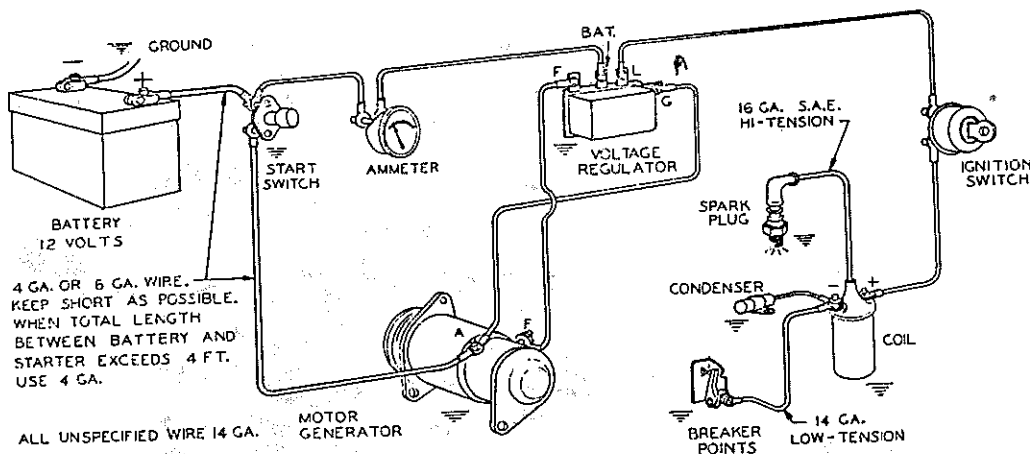
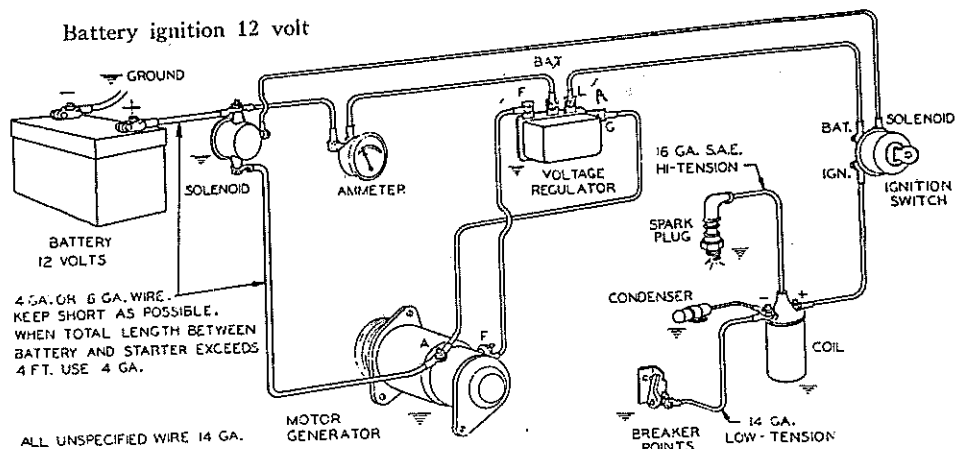

Figure 33
Adjusting voltage setting of current-voltage regulator unit.



Battery ignition 12 volt



Battery ignition 12 volts with cranking solenoid

Figure 34

GAS-GASOLINE SYSTEM

A combination gas-gasoline system is used on the K330/K331 engines. This system allows the engine to be operated on either fuel.

The gas fuel is supplied directly to the carburetor air intake through the secondary regulator mounted on the engine. By turning the engine over at a continuous rate, engine vacuum will open the secondary regulator and allow fuel to enter the combustion chamber. A priming button is located on the regulator to allow the gas to flow into the system for quicker starting.

1. To Operate on Gas

- a. Close gasoline valve on gasoline filter (E, Fig. 35).
- b. Disconnect electric choke lead wire (B, Fig. 35) and tape the end to prevent possibility of shorting.
- c. Open gas cock in gas supply line.
- d. Start engine. If unit has not been previously adjusted for correct fuel-air mixture, loosen locknut on mixture (C, Fig. 35) and turn valve until engine runs smoothly under load. Retighten locknut. If engine runs unsteady with no load, adjust idle screw (F, Fig. 35) if Ensign regulator is used. If Garretson regulator is used, no idle adjustment is necessary.

2. Changing From Gas To Gasoline Fuel

- a. Shut off gas cock in gas supply line which should be ahead of gas filter and gas regulator.
- b. Open gasoline valve on gasoline filter (E, Fig. 35).
- c. Connect electric choke lead.
- d. Start engine. Hand primer (C, Fig. 22) on fuel pump may be used to fill fuel system, if necessary, to minimize cranking period.

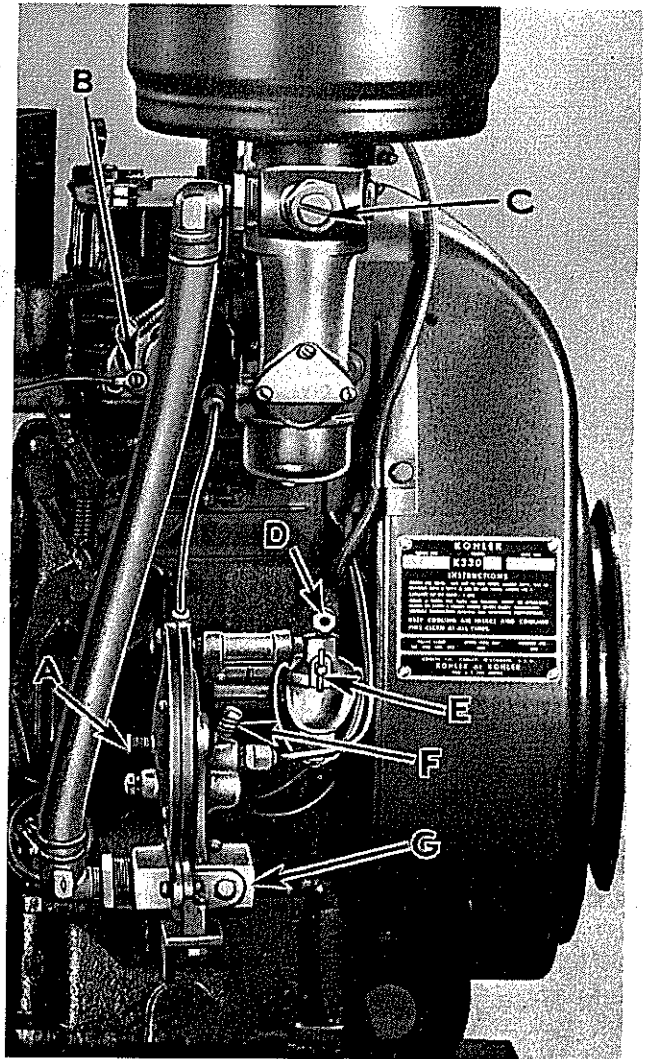
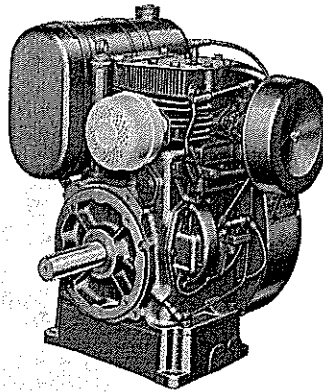

Figure 35

Gas-Gasoline Fuel System

- A - Gas Priming Button
- B - Auto Choke Lead
- C - Fuel/Air Mixture Valve
- D - Gasoline Inlet
- E - Gasoline Shut-off Valve
- F - Idle Adjustment Screw
- G - Gas Inlet



8.2 HP at 1800 RPM
 10.2 HP at 2400 RPM
 12.3 HP at 3000 RPM
 12.5 HP at 3200 RPM

SPECIFICATIONS

K 3 3 1

BORE AND STROKE: $3\frac{3}{8}$ x $3\frac{1}{4}$ inches.

PISTON DISPLACEMENT: 33.6 cubic inches.

IGNITION: High voltage flywheel magneto. Spark plug 14 mm.

SPARK ADVANCE MECHANISM: Automatically retards spark for easy starting and advances when engine speed is increased.

LUBRICATION: Gear type oil pump, supplying oil under pressure directly to the connecting rod.

OIL CAPACITY: 3 quarts.

BEARINGS: Main—anti-friction ball bearings on both ends of crankshaft. Connecting rod—high capacity, steel backed, copper lead insert.

GOVERNOR: Precision, oil bathed, flyweight type.

CRANKSHAFT: Heat treated ductile iron casting with integral counter-weights.

CONNECTING RODS: Forged aluminum alloy, heat treated.

PISTON: Low expansion aluminum alloy.

PISTON RINGS: Two compression, one oil control.

VALVES: Forged steel alloy intake, heat resistant steel alloy exhaust.

EXHAUST VALVE SEAT: Eatonite insert.

VALVE TAPPETS: Hardened and precision ground, equipped with clearance adjusting screw. Replaceable valve guides.

EXHAUST VALVE ROTATOR: Positive type insuring rotation during each valve cycle.

CYLINDER AND CRANKCASE: Metallurgically controlled close grained cylinder iron.

CYLINDER HEAD: Aluminum alloy with deep fins closely spaced for efficient cooling.

CARBURETOR: Float feed, adjustable type, for angle operation.

FUEL FILTER: Glass sediment bowl type with handy fuel shut off.

FUEL TANK: 2.8 gallon capacity.

FUEL PUMP: Automotive diaphragm type with priming lever.

DIRECTION OF ROTATION: Counterclockwise viewed from power take off side.

MODIFICATIONS

RADIO INTERFERENCE SUPPRESSION: Reduces radio and television interference created by engine ignition system.

HIGH TEMPERATURE CUT OUT THERMOSTAT: Provides protection against over heating by automatically stopping the engine when cylinder head temperature exceeds safe operating limits.

LOW OIL PRESSURE CUT OUT SWITCH: Automatically stops engine when oil pressure drops below safe operating limits. Safeguards against engine damage due to low oil pressure.

OIL FILTERS: Replacement element type filters, recommended for use under extremely dusty or dirty conditions.

SPECIAL CRANKSHAFT EXTENSION: Modified power take-off shafts are available for a variety of applications.

STELLITE FACED EXHAUST VALVE: For increased valve life. Standard equipment on K1331P engines.

STELLITE FACED INTAKE VALVE: Hard facing alloy provides longer life through increased resistance to high temperatures and wear.

L.P. OR NATURAL GAS OPERATION: Permits operation of engine on less expensive fuel; however horsepower rating is reduced.

TABLE OF RUNNING CLEARANCES

PARTS FITTED	SIZE OR CLEARANCE
Cylinder Bore - Standard	3.625
Closure plate to block	.001 - .005
Crankshaft end play - Pump Models	.003 - .008
Models other than pump	.005 - .010
Connecting rod to crankpin running clearance	.0003 - .0023
Connecting rod side play on crankpin	.011 - .007
Crankshaft - Connecting rod journal size	1.873
Connecting rod to wrist pin	.0003 - .0008
Wrist pin to piston boss	.0001 - .0003
Ring side clearance, top ring	.0025 - .0045
Ring side clearance, middle ring	.0025 - .0045
Ring side clearance, oil ring	.002 - .0035
Ring end gap	.007 - .017
Camshaft pin to camshaft running clearance	.0010 - .0025
Camshaft pin to block	.0015 - .0030
Breaker cam to camshaft pin	.0025 - .0010
Camshaft end play	.005 - .010
Tappet in block	.0008 - .0023
Valve stem in guide	Exh.- .002 - .0035 Int.- .0005 - .002
Guide in block	.0005 - .002
Exhaust valve seat in block	.0025 - .0045
Transfer bearing to crankshaft, oil clearance	.001 - .0035
Crankshaft gear to crankshaft	.001 - .0015
Output shaft seal to closure plate	.001 - .007
Governor gear to governor shaft	.0005 - .0015
Piston to cylinder bore clearance (top thrust face)	.0015 - .0005
Valve clearance intake (cold)	.008
Valve clearance exhaust (cold)	.020
Spark plug gap	.025
Breaker points	.020
Spark, run	15° B.T.D.C.
Spark, retard	2° A.T.D.C.

TABLE OF TORQUE VALUES

Spark plug	14 mm	27 ft. lb.
Screw, connecting rod	3/8	35 ft. lb.
*Screw, cylinder head	3/8	40 ft. lb.
*Stud, cylinder head	3/8	40 ft. lb.
Nut, flywheel	3/4	100 ft. lb.

*Lubricate with grease at assembly.

Always use torque wrench on above parts.

CURRENT - VOLTAGE REGULATOR

Voltage Regulator:

Air Gap	.075 inch
Setting Range	13.6 to 14.5 volts
Adjust To	14 volts

Cut-out Relay:

Air Gap	.020 inch
Point Opening	.020 inch
Closing Voltage	11.8 to 14 volts
Adjust To	12.8 volts